

# Weller®



## WR 2, WR 3M

- DE** Originalbetriebsanleitung
- GB** Translation of the original instructions
- ES** Traducción del manual original
- FR** Traduction de la notice originale
- IT** Traduzione delle istruzioni originali
- PT** Tradução do manual original
- NL** Vertaling van de oorspronkelijke gebruiksaanwijzing
- SV** Översättning av bruksanvisning i original
- DK** Oversættelse af den originale brugsanvisning
- FI** Alkuperäisten ohjeiden käännös
- GR** Μετάφραση του πρωτοτύπου των οδηγιών χρήσης
- TR** Orijinal işletme talimatı çevirisi
- CZ** Překlad původního návodu k používání
- PL** Tłumaczeniem instrukcji oryginalnej
- HU** Eredeti használati utasítás fordítása
- SK** Preklad pôvodného návodu na použitie
- SL** Prevod izvirnih navodil
- EE** algupärase kasutusjuhendi tõlge
- LV** Instrukciju tulkojumam no oriģinālvalodas
- LT** Originalios instrukcijos vertimas
- BG** Превод на оригиналната инструкция
- RO** Traducere a instructiunilor originale
- HR** Prijevod originalnih uputa
- RU** Оригинальное руководство по эксплуатации

## Quick Reference WR 2

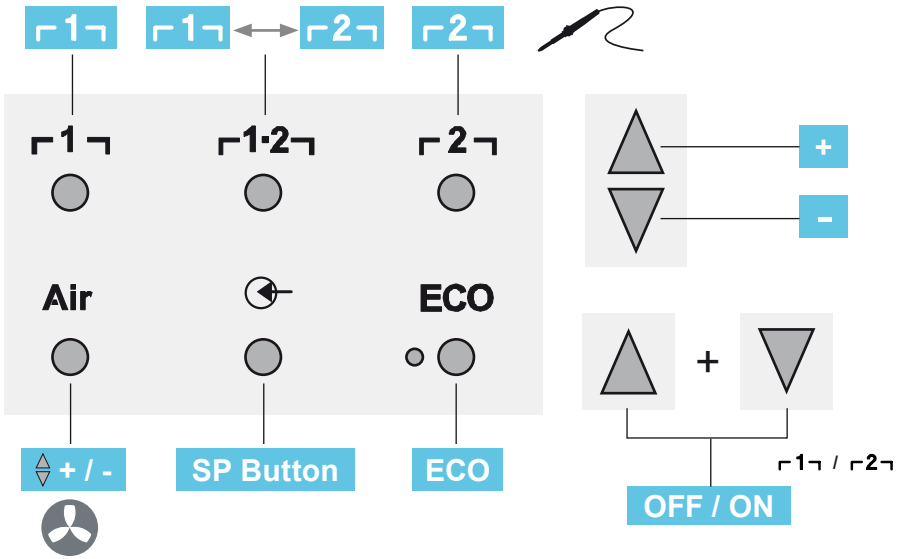

## Quick Reference WR 3M

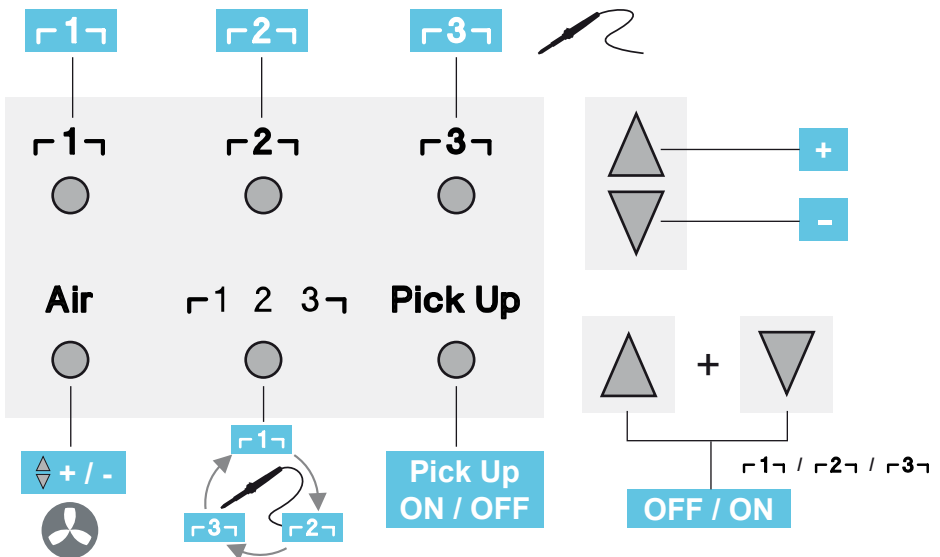

DE Menüaufwurf  
 GB Open Menu  
 ES Acceso al Menú  
 FR Appel du menu  
 IT Richiama il menu  
 PT Activação do menu  
 NL Oproep Menu  
 SV Öppna meny

DK Hentning af menu  
 FI Valikon haku näyttöön  
 GR Κλήση μενού  
 TR Menüsunü açma  
 CZ Spuštění Nabídky položek  
 PL Wywołanie menu  
 HU Menü előhívása  
 SK Vyvolanie menu

SL Prklic menija  
 EE Menüü avamine  
 LV Izvēlnes izsaukšana  
 LT Meniu iškvietia  
 BG Повикване на менюто  
 RO Apelarea meniului  
 HR Pozivanje izbornika  
 RU Вызов Меню

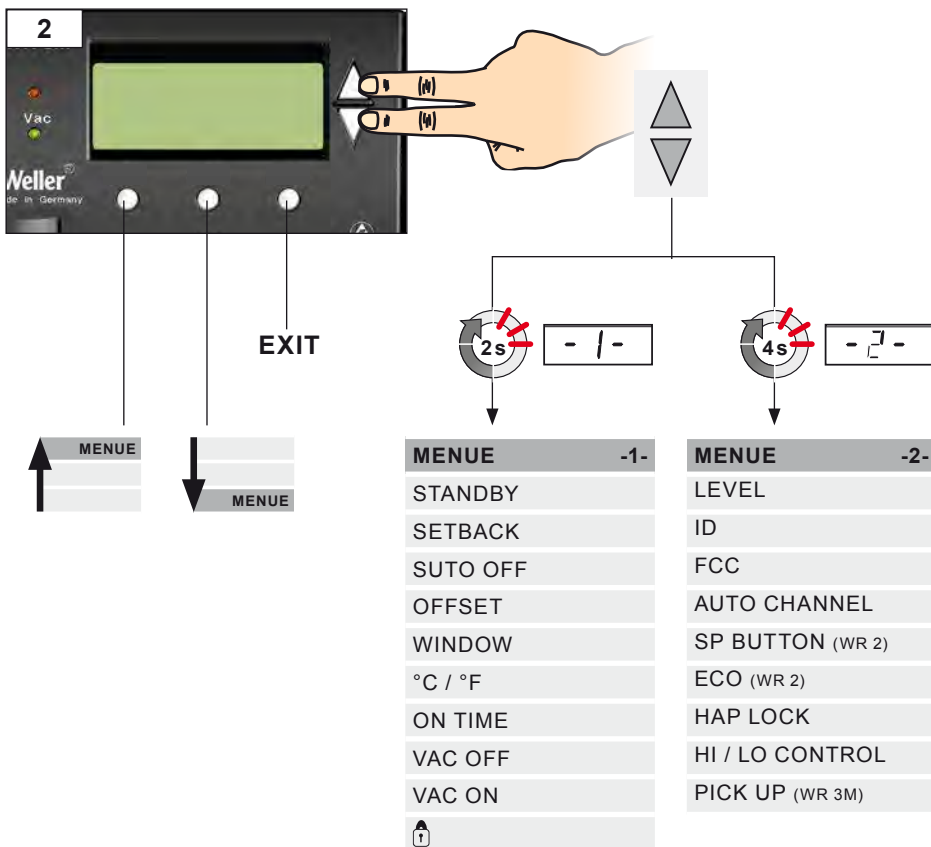
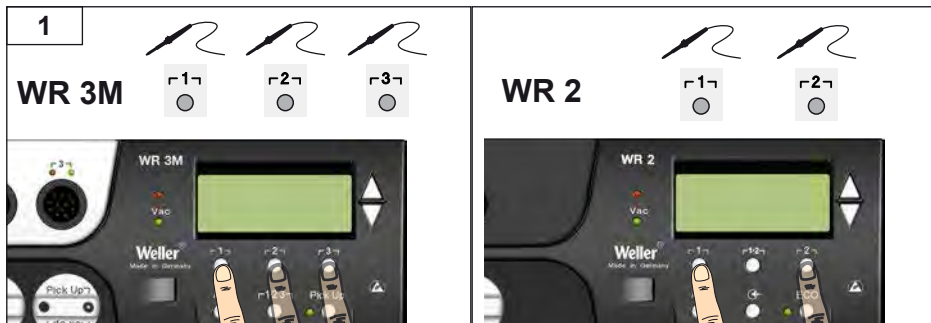

# WR 2

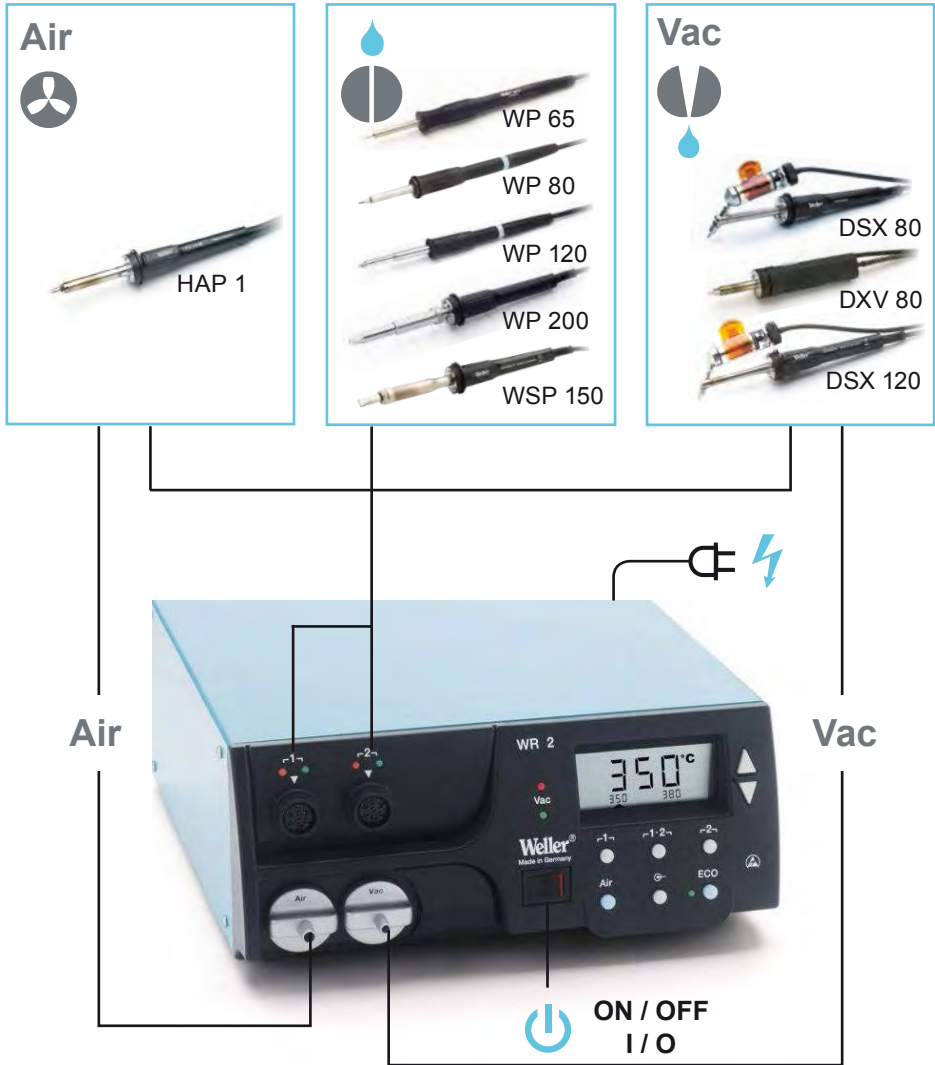

Air



HAP 1



WP 65

WP 80

WP 120

WP 200

WSP 150

Vac



DSX 80

DXV 80

DSX 120

Air

WR 2



Vac

-1-

-2-

-1-

-1-2-

-2-

Air

ECO

ECO



ON / OFF  
I / O

# WR 3M

**Air**



HAP 200



HAP 1



WP 65

WP 80

WP 120

WP 200

WSP 150

WMRP

**Vac**



WMRT

DSX 80

DXV 80

DSX 120

**Air**

**Vac**



**ON / OFF**  
**I / O**

**Pick Up**



WVP



WRK

DE Lieferumfang  
 GB Included in delivery  
 ES Piezas suministradas  
 FR Fourniture  
 IT Dotazione  
 PT Fornecimento  
 NL Meegeleverd van de levering  
 SV Leveransomfattning

DK Leveringsomfang  
 FI Toimitussisältö  
 GR Υλικά παράδοσης  
 TR Teslimat kapsamı  
 CZ Rozsah dodávky  
 PL Zakres dostawy  
 HU Szállítási terjedelem  
 SK Rozsah dodávky

SL Obseg pošiljke  
 EE Tame sisu  
 LV Piegādes komplekts  
 LT Komplektas  
 BG Обем на доставката  
 RO Pachetul de livrare  
 HR Popratna oprema  
 RU Комплект поставки



## WR 2



## WR 3M



DE Zubehör  
 GB Accessory  
 ES Accesorio  
 FR Accessoires  
 IT Accessorio  
 PT Acessório  
 NL Toebehoren  
 SV Tillbehör

DK Tilbehør  
 FI Lisälaite  
 GR Εξαρτήματα  
 TR Aksesuar  
 CZ Příslušenství  
 PL Wyposażenie  
 HU Tartozék  
 SK Príslušenstvo

SL Oprema  
 EE Tarvikud  
 LV Piederumi  
 LT Priedas  
 BG Принадлежности  
 RO Accesorii  
 HR Pribor  
 RU Оснастка



WHP 80



WSB 150



WSB 80



WST 82

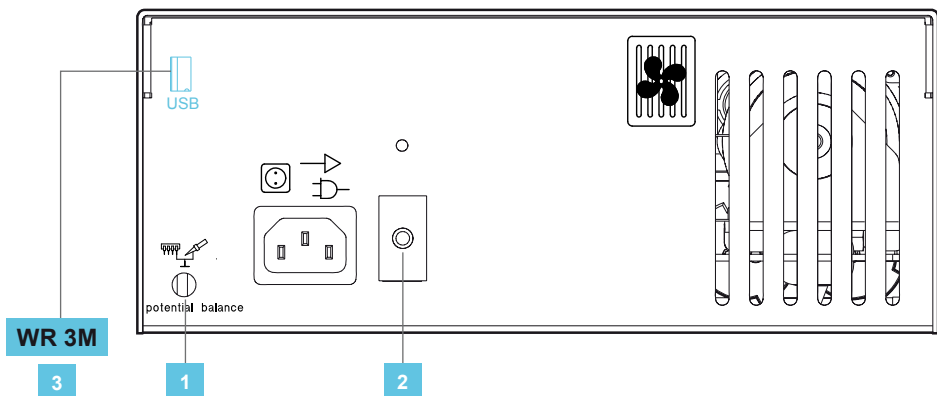

<p><b>1</b></p>	<p>DE Potentialausgleich            GB Equipotential bonding            ES Equipotencial            FR Compensation de potentiel            IT Compensazione di potenziale            PT Equilíbrio do potencial            NL Potentiaalvereffening            SV Potentialutjämning            DK Spændingsudligning</p>	<p>FI Potentialin tasaus            GR Εξίσωση δυναμικού            TR Potansiyel dengelemesi            CZ Vyrovnání potenciálu            PL Wyrównanie potencjału            HU Feszültségkiegyenlítő hűvelő            SK Zásuvka vyrovnania potenciálov            SL Vtičnica za izenačevanje potenciala</p>	<p>EE Potentsiaalide ühtlustuspüks            LV Potenciālu izlīdzināšanas pieslēgvieta            LT Potencialo išlyginimo įvoret            BG Изравняване на потенциалите            RO Egalizare de potențial            HR Izjednačavanje potencijala            RU Выравнивание потенциалов</p>
<p><b>2</b></p>	<p>DE Netzsicherung            GB Mains fuse            ES Fusible            FR Fusible secteur            IT Protezione della rete            PT Fusível de rede            NL Netbeveiliging            SV Nätsäkring</p>	<p>DK Netsikring            FI Verkkosulake            GR Ηλεκτρική ασφάλεια δικτύου            TR Şebeke sigortası            CZ Síťová pojistka            PL Bezpiecznik sieciowy            HU Hálózati biztosíték            SK Siet'ová poistka</p>	<p>SL Omrežna varovalka            EE Võrgukaitse            LV Elektriskā tīkla drošinātājs            LT Tinklo saugiklis            BG Мрежов предпазител            RO Siguranță de rețea            HR Mrežni osigurač            RU Предохранитель электросети</p>
<p><b>3</b></p>	<p>DE USB-Schnittstelle            GB USB port            ES Interfaz USB            FR Interface USB            IT Interfaccia USB            PT Interface USB            NL USB-poort            SV USB-port</p>	<p>DK USB-port            FI USB-liitäntä            GR Ούρα διεπαφής USB            TR USB arabirim            CZ Rozhraní USB            PL Złącze USB            HU USB csatlakozó            SK Rozhranie USB</p>	<p>SL Vmesnik USB            EE USB-liides            LV USB pieslēgvieta            LT USB sąsaja            BG USB-интерфейс            RO Interfață USB            HR Sučelje USB            RU Интерфейс USB</p>
<p><b>4</b></p>	<p>DE Aktiver Kanal / Optische Regelkontrolle            GB Active channel / Visual control check            ES Canal activo / Control óptico de regulación            FR Canal actif / Contrôle optique de régulation            IT Canale attivo / Controllo di regolazione ottico            PT Canal ativo / Controlo de regulação óptico            NL Actief kanaal / Optische regelcontrole            SV Aktiv kanal / Optisk reglerkontroll</p>	<p>DK Aktiv kanal / Optisk indstillingskontrolle            FI Aktiivoitu kanava / Optinen säätövalvonta            GR Ενεργό κανάλι / Οοπτικός έλεγχος ρύθμισης            TR Aktif kanal / Optik ayar kontrolü            CZ Aktivní kanál / Optická kontrola regulace            PL Aktywny kanał / Optyczna kontrola regulacji            HU Aktiv csatorna / Optikai szabályozóellenőrző            SK Aktivný kanál / Optická kontrola regulácie</p>	<p>SL Aktivni kanal / Optična kontrola regulacije            EE Aktiivne kanal / Optiline regulaatorikontroll            LV Aktīvais kanāls / Optiskā regulēšanas kontrole            LT Aktyvus kanalas / Optinė reguliavimo kontrolė            BG Активен канал / Оптичен контрол на регулирането            RO Canal activ / Controlul optic al setărilor            HR Aktivni kanal / Optička regulacija            RU Активный канал / Оптический контроль регулировки</p>

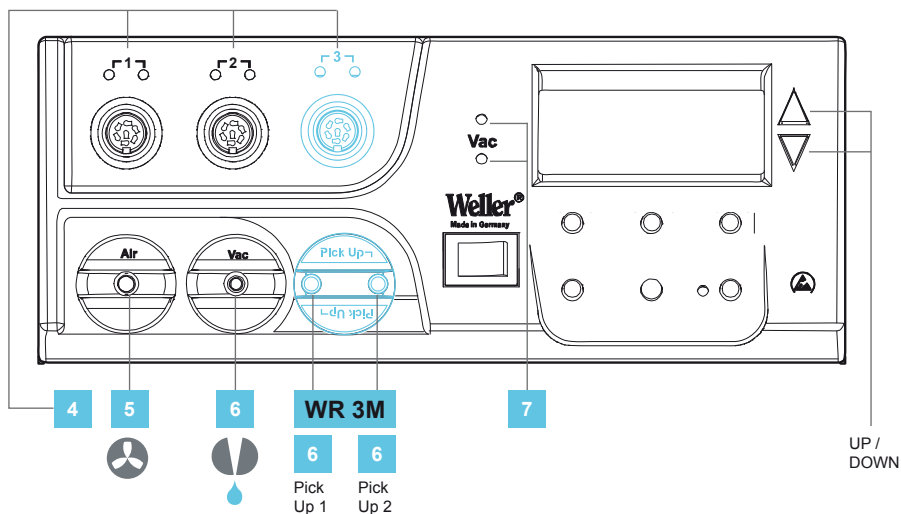

- |   |  |   |
|---|--|---|
| <p><b>5</b> DE Luftanschlussnippel für Heißluftkolben<br/>           GB Air connection nipple for hot air tools<br/>           ES Boquilla de conexión del aire para el soldador de aire caliente<br/>           FR Raccord de connexion d'air pour fers à air chaud<br/>           IT Nipplo di collegamento aria per saldatore ad aria calda<br/>           PT Niples de ligação de ar para ferros de soldar por ar quente<br/>           NL Luchtaansluitnippel voor heteluchtbout<br/>           SV Luftanslutningsnippel för hetluftspenna</p> | <p><b>DK</b> Lufttilslutningsnippel til varmluftskolbe<br/>           FI Ilmaliitäntänippa kuumailmakolville<br/>           GR Στόμιο σύνδεσης αέρα για έμβολο θερμού αέρα<br/>           TR Sicak hava pistonu için hava bađlantı nipelı<br/>           CZ Šroubovacı přípojka vzduchu pro horkovzdušný pist<br/>           PL Šroubovacı přípojka vzduchu pro horkovzdušný pist<br/>           HU Levegőcsatlakozó a forrólevegős páka számára<br/>           SK Prípojka vzduchu pre teplovzdušnú rúčku</p> | <p><b>SL</b> Priključni nastavek spajkalnika za vroči zrak<br/>           EE Õhuühenduse nippel kuuma õhu kolvidele<br/>           LV Gaisa pieslēguma nipelis karstā gaisa lodāmuram<br/>           LT Karšto oro stūmoklio oro jungties antgalis<br/>           BG Нипел за присъединяван на въздух за поялник с горещ въздух<br/>           RO Niplu de racordare pentru letconul cu aer cald<br/>           HR Nazuvica za priključak zraka za lemilo na vrući zrak<br/>           RU Подключение воздуха ниппель для горячей пайки воздуха</p> |
| <p><b>6</b> DE Vakuumanschluss<br/>           GB Vacuum connection<br/>           ES Toma de vacío<br/>           FR Raccord de vide<br/>           IT Collegamento per vuoto<br/>           PT Ligação de vácuo<br/>           NL Vacuümaansluiting<br/>           SV Vakuumanslutning<br/>           DK Vakuumtilslutning</p>   | <p><b>FI</b> Tyhjiiitântä<br/>           GR Σύνδεση κενού<br/>           TR Vakum bađlantısı<br/>           CZ Přípojka vakua<br/>           PL Prłączce próżni<br/>           HU Vákuumcsatlakozó<br/>           SK Prípojka vákua<br/>           SL Priključek za podtlak<br/>           EE Vaakumühendus</p>  | <p><b>LV</b> Vakuuma pieslēgums<br/>           LT Vakuumo jungtis<br/>           BG Съединителен елемент за вакуум<br/>           RO Racord pentru vid<br/>           HR Vakuumski priključak<br/>           RU Вакуумное соединение</p>  |
| <p><b>7</b> DE LED Vakuum<br/>           GB Vacuum LED<br/>           ES LED Vacío<br/>           FR LED vide<br/>           IT LED Vuoto<br/>           PT LED do vácuo<br/>           NL LED vacuüm<br/>           SV Lysdiod vakuum</p>  | <p><b>DK</b> LED vakuum<br/>           FI Tyhjiön LED<br/>           GR LED κενού<br/>           TR Vakum LED'i<br/>           CZ LED vakuum<br/>           PL Dioda LED próżni<br/>           HU Vákuum LED<br/>           SK LED-dióda: podtlak</p>  | <p><b>SL</b> LED-dioda podtlaka<br/>           EE LED vaakum<br/>           LV Vakuuma LED diode<br/>           LT LED vakuumas<br/>           BG Вакуум LED<br/>           RO LED vid<br/>           HR LED vakuum<br/>           RU Светодиодный индикатор вакуума</p>  |



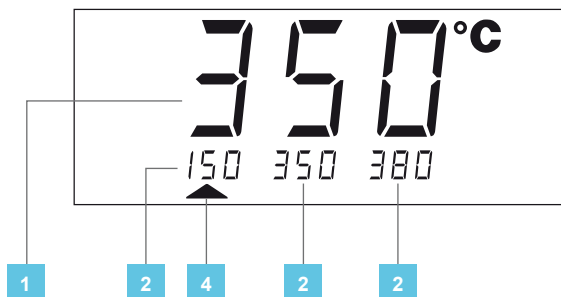

<p><b>1</b></p> <p><b>DE</b> Isttemperatur / Solltemperatur  <b>GB</b> Actual temperature / nominal temperature  <b>ES</b> Temperatura real / temperatura de referencia  <b>FR</b> Température réelle / température de consigne  <b>IT</b> Temperatura reale / temperatura nominale  <b>PT</b> Temperatura real / temperatura nominal  <b>NL</b> Werkelijke temperatuur / gewenste temperatuur  <b>SV</b> Faktisk temperatur / börtemperatur</p>	<p><b>DK</b> Faktisk temperatur / nominal temperatur  <b>FI</b> Todellinen lämpötila / ohjelämpötila  <b>GR</b> Πραγματική θερμοκρασία / ονομαστική θερμοκρασία  <b>TR</b> Fiili sıcaklık / nominal sıcaklık  <b>CZ</b> Skutečná teplota / nominal sıcaklık  <b>PL</b> Temperatura rzeczywista / temperatura zadana  <b>HU</b> Mért hőmérséklet / temperatura hőmérséklet  <b>SK</b> Skutočná teplota / požadovaná teplota</p>	<p><b>SL</b> Dejanska temperatura / zelena temperatura  <b>EE</b> Tegelik väärtus / sihttemperatuur  <b>LV</b> Faktiskā temperatūra / vēlamā temperatūra  <b>LT</b> Esama temperatūra / nustatytoji temperatūra  <b>BG</b> Действителна температура / Зададена температура  <b>RO</b> Temperatura efectivă / Temperatura nominală  <b>HR</b> Stvarna temperatura / Zadana temperatura  <b>RU</b> Фактическая температура / Заданная температура</p>
<p><b>2</b></p> <p><b>DE</b> Festtemperatur  <b>GB</b> Fixed temperature  <b>ES</b> Temperatura fija  <b>FR</b> Température fixe  <b>IT</b> Temperatura fissa  <b>PT</b> Temperatura fixa  <b>NL</b> Vaste temperatuur  <b>SV</b> Fast temperatur</p>	<p><b>DK</b> Fast temperatur  <b>FI</b> Kiinteä lämpötila  <b>GR</b> Σταθερή θερμοκρασία  <b>TR</b> Sabit sıcaklık  <b>CZ</b> Stanovená teplota  <b>PL</b> Temperatura stała  <b>HU</b> Rögzített hőmérséklet  <b>SK</b> Pevná teplota</p>	<p><b>SL</b> Stalna temperatura  <b>EE</b> Püsitemperatuur  <b>LV</b> Noteiktā temperatūra  <b>LT</b> Fiksuotoji temperatūra  <b>BG</b> Непроменлива температура  <b>RO</b> Temperatura fixă  <b>HR</b> Fiksna temperatura  <b>RU</b> Фиксированная температура</p>
<p><b>3</b></p> <p><b>DE</b> Anzeige Sonderfunktionen  <b>GB</b> Special functions display  <b>ES</b> Indicación de funciones especiales  <b>FR</b> Affichage fonctions spéciales  <b>IT</b> Indicatore delle funzioni speciali  <b>PT</b> Indicação das funções especiais  <b>NL</b> Weergave speciale functies  <b>SV</b> Indikering specialfunktioner</p>	<p><b>DK</b> Visning af specialfunktioner  <b>FI</b> Erikoistoimintojen näyttö  <b>GR</b> Ένδειξη ειδικών λειτουργιών  <b>TR</b> Özel fonksiyonlar göstergesi  <b>CZ</b> Ukazatel speciálních funkcí  <b>PL</b> Wskazanie funkcji specjalnych  <b>HU</b> Különleges funkciók kijelző  <b>SK</b> Zobrazenie špeciálnych funkcií  <b>SL</b> Prikaz posebnih funkcij</p>	<p><b>EE</b> Erifunktsioonide näidik  <b>LV</b> Īpašo funkciju rādītājs  <b>LT</b> Specialiųjų funkcijų rodmuo  <b>BG</b> Индикация: специални функции  <b>RO</b> Afișarea funcțiilor speciale  <b>HR</b> Prikaz posebnih funkcija  <b>RU</b> Индикация специальных функций</p>

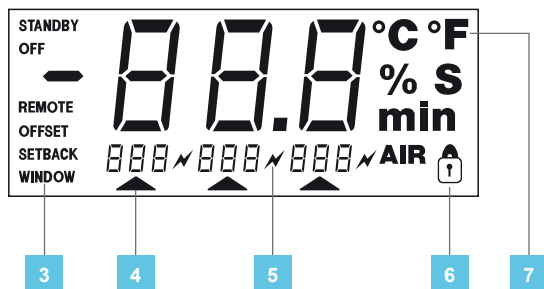

- |          |   |  |  |
|----------|---|--|--|
| <b>4</b> | <p><b>DE</b> Anzeige Kanalwahl<br/> <b>GB</b> Channel selection display<br/> <b>ES</b> Indicación del canal seleccionado<br/> <b>FR</b> Affichage choix du canal<br/> <b>IT</b> Indicazione della scelta canale<br/> <b>PT</b> Indicação da selecção de canal<br/> <b>NL</b> Indicatie kanaalkeuze<br/> <b>SV</b> Indikering kanalval</p> | <p><b>DK</b> Visning af kanalvalg<br/> <b>FI</b> Kanavanvalinnan näyttö<br/> <b>GR</b> Ένδειξη επιλογής καναλιού<br/> <b>TR</b> Kanal seçimi göstergesi<br/> <b>CZ</b> Ukazatel zvoleného kanálu<br/> <b>PL</b> Wskazanie wyboru kanału<br/> <b>HU</b> Csatornaválasztás kijelző<br/> <b>SK</b> Zobrazenie výberu kanálu<br/> <b>SL</b> Prikaz izbire kanala</p> | <p><b>EE</b> Kanalivaliku näidik<br/> <b>LV</b> Kanāla izvēles rādītjums<br/> <b>LT</b> Pasirinkto kanalo rodmuo<br/> <b>BG</b> Индикация: избор на канал<br/> <b>RO</b> Afişarea selectării canalului<br/> <b>HR</b> Prikaz odabira kanala<br/> <b>RU</b> Индикация выбора канала</p> |
|----------|---|--|--|

- |          |  |   |  |
|----------|--|---|--|
| <b>5</b> | <p><b>DE</b> Optische Regelkontrolle<br/> <b>GB</b> Visual control check<br/> <b>ES</b> Control óptico de regulación<br/> <b>FR</b> Contrôle optique de régulation<br/> <b>IT</b> Controllo di regolazione ottico<br/> <b>PT</b> Controlo de regulação óptico<br/> <b>NL</b> Optische regelcontrole<br/> <b>SV</b> Optisk reglerkontroll<br/> <b>DK</b> Optisk indstillingskontrol</p> | <p><b>FI</b> Optinen säätövalvonta<br/> <b>GR</b> Οπτικός έλεγχος ρύθμισης<br/> <b>TR</b> Optik ayar kontrolü<br/> <b>CZ</b> Optická kontrola regulace<br/> <b>PL</b> Optyczna kontrola regulacji<br/> <b>HU</b> Optikai szabályozóellenőrző<br/> <b>SK</b> Optická kontrola regulácie<br/> <b>SL</b> Optična kontrola regulacije<br/> <b>EE</b> Optiline regulaatorikontroll</p> | <p><b>LV</b> Optiskā regulēšanas kontrole<br/> <b>LT</b> Optinė reguliavimo kontrolė<br/> <b>BG</b> Оптичен контрол на регулирането<br/> <b>RO</b> Controlul optic al setărilor<br/> <b>HR</b> Optička regulacija<br/> <b>RU</b> Оптический контроль регулировки</p> |
|----------|--|---|--|

- |          |   |  |   |
|----------|---|--|---|
| <b>6</b> | <p><b>DE</b> Verriegelung<br/> <b>GB</b> Interlock<br/> <b>ES</b> Bloqueo<br/> <b>FR</b> Verrouillage<br/> <b>IT</b> Bloccaggio<br/> <b>PT</b> Bloqueio<br/> <b>NL</b> Vergrendeling<br/> <b>SV</b> Låsning</p> | <p><b>DK</b> Lås<br/> <b>FI</b> Lukitus<br/> <b>GR</b> Κλειδώμα<br/> <b>TR</b> Kilitleme<br/> <b>CZ</b> Zablokování<br/> <b>PL</b> Blokada<br/> <b>HU</b> Rendszerelés<br/> <b>SK</b> Zablokovanie</p> | <p><b>SL</b> Zaklepanje<br/> <b>EE</b> Lukustamine<br/> <b>LV</b> Bloķēšana<br/> <b>LT</b> Užraktas<br/> <b>BG</b> Блокировка<br/> <b>RO</b> Blocare<br/> <b>HR</b> Zaključavanje<br/> <b>RU</b> Блокировка</p> |
|----------|---|--|---|

- |          |   |   |  |
|----------|---|---|--|
| <b>7</b> | <p><b>DE</b> Temperatursymbol °C/°F<br/> <b>GB</b> Temperature symbol °C/°F<br/> <b>ES</b> Símbolo de temperatura °C/°F<br/> <b>FR</b> Symbole de température °C/°F<br/> <b>IT</b> Simbolo della temperatura °C/°F<br/> <b>PT</b> Símbolo de temperatura °C/°F<br/> <b>NL</b> Temperatuursymbol °C/°F<br/> <b>SV</b> Temperatursymbol °C/°F</p> | <p><b>DK</b> Temperatursymbol °C/°F<br/> <b>FI</b> Lämpötilatunnus °C/°F<br/> <b>GR</b> Σύμβολο θερμοκρασίας °C/°F<br/> <b>TR</b> Sıcaklık sembolü °C/°F<br/> <b>CZ</b> Symbol teploty °C/°F<br/> <b>PL</b> Symbol temperatury °C/°F<br/> <b>HU</b> Hőmérséklet szimbólum °C/°F<br/> <b>SK</b> Symbol teploty °C/°F</p> | <p><b>SL</b> Simbol za temperaturo °C/°F<br/> <b>EE</b> Temperatuurisümbol °C/°F<br/> <b>LV</b> Temperatūras simbols °C/°F<br/> <b>LT</b> Temperatūros simbolis °C/°F<br/> <b>BG</b> Символ на температурата °C/°F<br/> <b>RO</b> Simbol de temperatură °C/°F<br/> <b>HR</b> Simbol za temperaturu °C/°F<br/> <b>RU</b> Символ температуры °C/°F</p> |
|----------|---|---|--|

DE Inbetriebnahme  
 GB Starting up the device  
 ES Puesta en servicio del aparato  
 FR Mise en service de l'appareil  
 IT Messa in funzione dell'apparecchio  
 PT Colocação do aparelho em serviço  
 NL Toestel in gebruik nemen  
 SV Ta lödstationen i drift  
 DK Ibrugtagning af apparatet  
 FI Laitteen käyttöönotto  
 GR Θέση της συσκευής σε λειτουργία  
 TR Cihazı işletime alma

CZ Uvedení zařízení do provozu  
 PL Uruchamianie urządzenia  
 HU A készülék üzembe helyezésé  
 SK Uvedenie zariadenia do prevádzky  
 SL Začetek dela z napravo  
 EE Seadme kasutusselevõtt  
 LV Iekārtas lietošanas sākšana  
 LT Prietaiso paruošimas eksploatuoti  
 BG Включване на уреда  
 RO Punerea în funcțiune a aparatului  
 HR Uređaj pustiti u rad  
 RU Ввод устройства в эксплуатацию

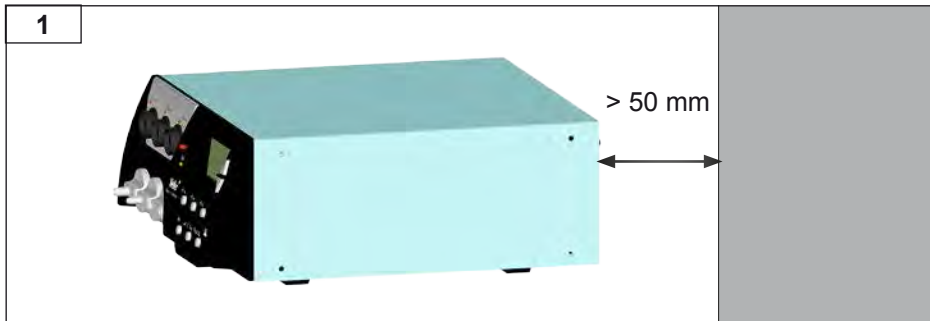

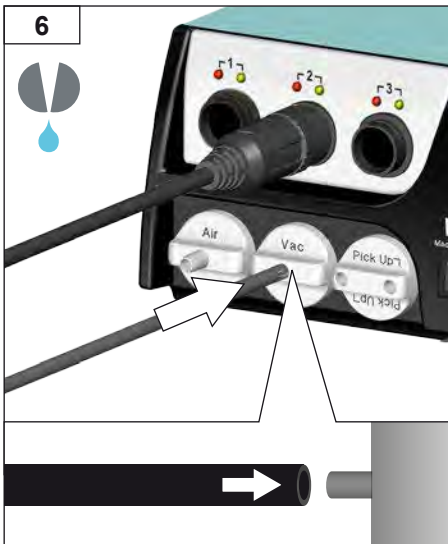
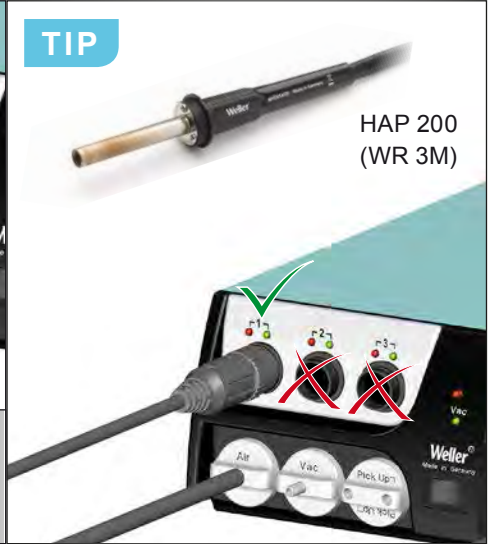
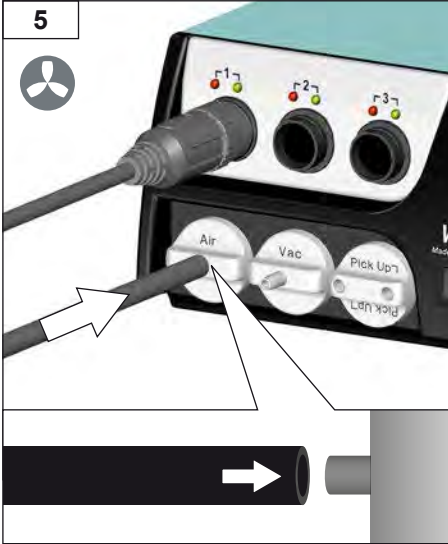
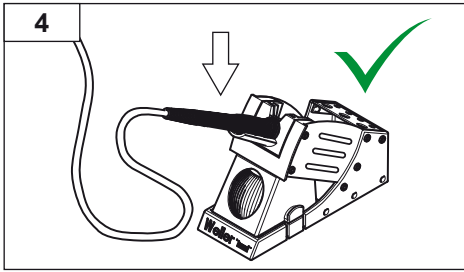

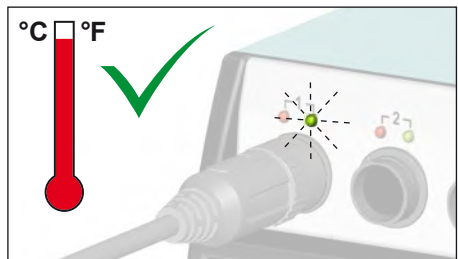
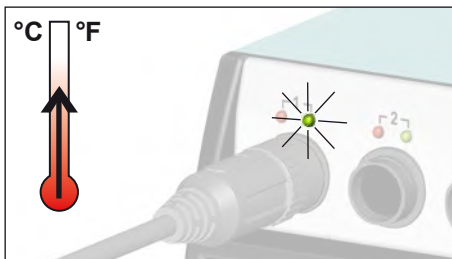
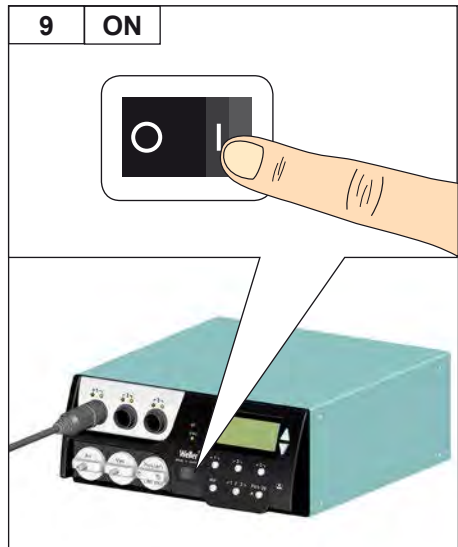
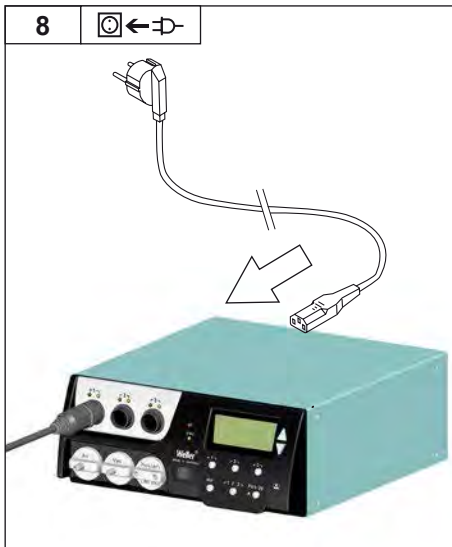
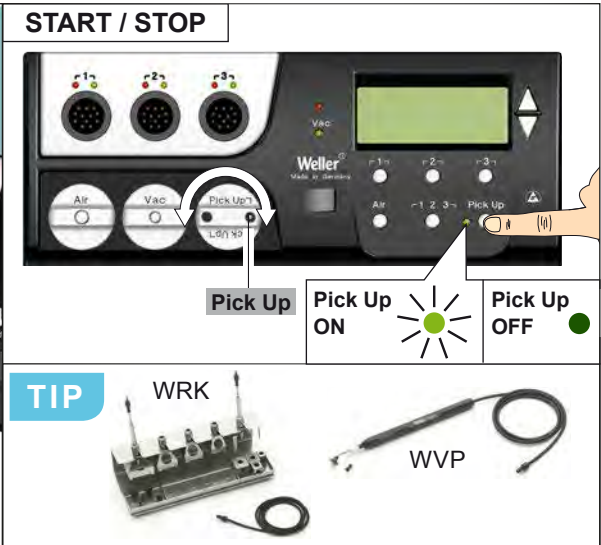

DE Filterwechsel  
 GB Filter change  
 ES Cambio de filtro  
 FR Remplacement du filtre  
 IT Sostituzione del filtro  
 PT Troca do filtro  
 NL Wissel van de filter  
 SV Byte av filter  
 DK Filterskift  
 FI Suodattimen vaihto  
 GR Αλλαγή φίλτρου  
 TR Filtre deęişimi

CZ Výměna filtru  
 PL Wymiana filtra  
 HU Szűrőcsere  
 SK Výmena filtra  
 SL Menjava filtra  
 EE Filtri vahetamine  
 LV Filtra nomaiņa  
 LT Filtrų keitimas  
 BG Смяна на филтъра  
 RO Schimbarea filtrului  
 HR Mjenjanje filtra  
 RU Замена фильтров

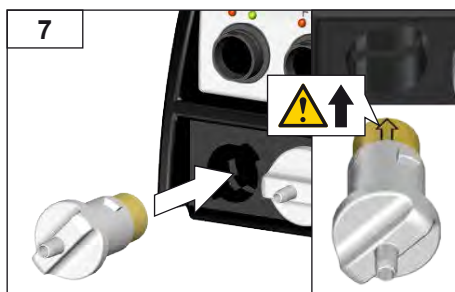
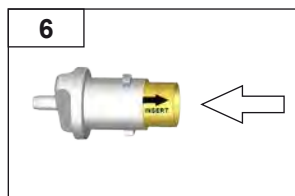
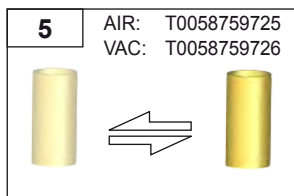
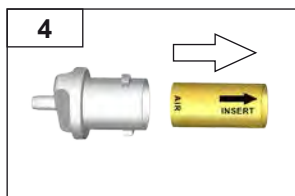
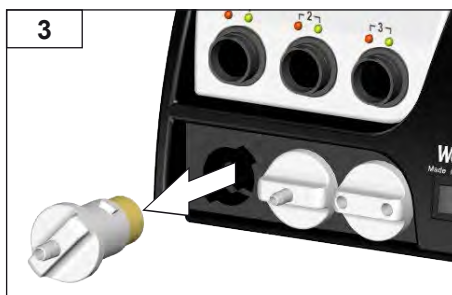
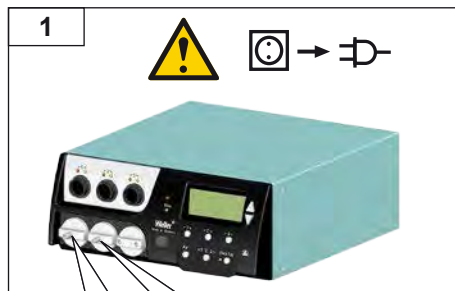

DE Heißluft  
 GB Hot air  
 ES Aire caliente  
 FR Air chaud  
 IT Aria calda  
 PT Ar quente  
 NL Hete lucht  
 SV Hetluft  
 DK Varmluft  
 FI Kuumailma  
 GR Καυτός αέρας  
 TR Sıcak hava

CZ Horký vzduch  
 PL Gorące powietrze  
 HU Forrólevegő  
 SK Horúci vzduch  
 SL Vroč zrak  
 EE kuum õhk  
 LV Karsts gaiss  
 LT Karštas oras  
 BG Горещ въздух  
 RO Aer cald  
 HR Vrući zrak  
 RU Нагретый воздух

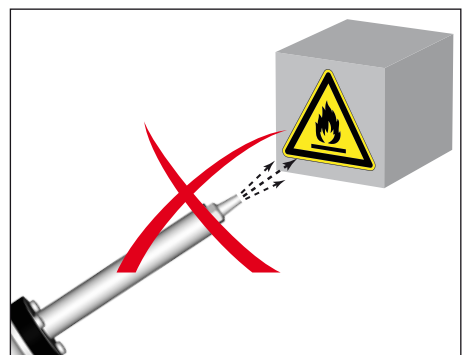
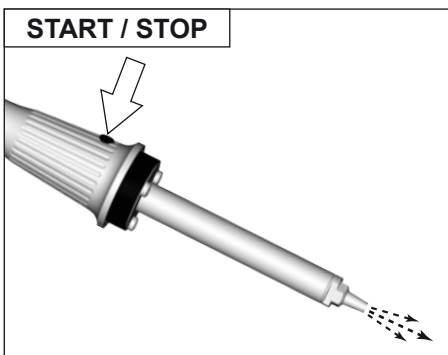
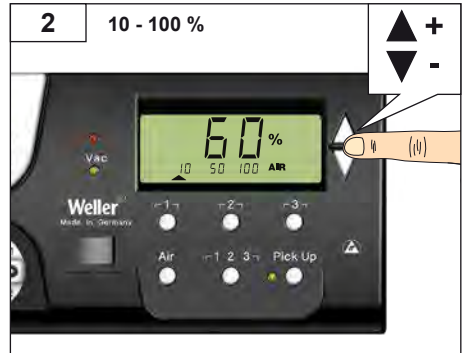
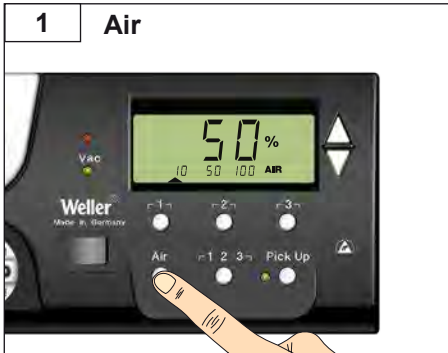

DE Bedienprinzip  
 GB Operating principle  
 ES Manejo  
 FR Principe d'utilisation  
 IT Concezione di comando  
 PT Princípio básico de operação  
 NL Bedieningsprincipe  
 SV Manövreringsprincip  
 DK Betjeningsprincip  
 FI Käyttöperiaate  
 GR Αρχή χειρισμού  
 TR Kullanım prensibi

CZ Princip obsluhy  
 PL Zasada obsługi  
 HU Működési elv  
 SK Princíp obsluhy  
 SL Potek upravljanja  
 EE Käsitsuspõhimõte  
 LV Vadības princips  
 LT Valdymo būdas  
 BG Принцип на управление  
 RO Principiul de operare  
 HR Način rada  
 RU Принцип действия

**WR 2** >> **PAGE 19 - 24**



**WR 3M** >> **PAGE 25 - 30**





DE Kanal auswählen  
 GB Select channel  
 ES Seleccionar canal  
 FR Sélectionner un canal  
 IT Selezione del canale  
 PT Seleccionar o canal  
 NL Kanaal selecteren  
 SV Välj kanal.  
 DK Vælg kanal  
 FI Kanavan valinta  
 GR Επιλογή καναλιού  
 TR Kanal seçimi

CZ Volba kanálu  
 PL Wybór kanału  
 HU Csatorna kiválasztás  
 SK Zvoľte kanál  
 SL Izbira kanala  
 EE kanali valimine  
 LV Kanāla izvēle  
 LT Pasirinkite kanalą  
 BG Изберете канал  
 RO Selectarea canalului  
 HR Odaberite kanal  
 RU Выбор канала

1

1



2

2



DE Kanal wechseln  
 GB Change channel  
 ES Cambiar de canal  
 FR Changer de canal  
 IT Cambio del canale  
 PT Mudar o canal  
 NL Kanaal wisselen  
 SV Byt kanal  
 DK Skift kanal  
 FI Kanavan vaihto  
 GR Αλλαγή καναλιού  
 TR Kanal deđiştirme

CZ Změna kanálu  
 PL Zmiana kanału  
 HU Csatornaváltás  
 SK Zmeňte kanál  
 SL Menjava kanala  
 EE kanali vahetamine  
 LV Kanāla nomaīņa  
 LT Pakeiskite kanalą  
 BG Прoмяна на канал  
 RO Schimbarea canalului  
 HR Promijenite kanal  
 RU Смена канала



WR 2

DE Kanal ein-/ ausschalten  
 GB Switching the channel on/ off  
 ES Conexión/ Desconexión del canal  
 FR Activation / désactivation du canal  
 IT Attivazione/ Disattivazione di un canale  
 PT Desligar/ ligar o canal  
 NL Kanaal uit-/ inschakelen  
 SV Koppla in/ ur kanal  
 DK Deaktivering/ aktivering af kanal  
 FI Kanavan pois-/ päällekytkentä  
 GR Απενεργοποίηση/ ενεργοποίηση καναλιού  
 TR Kanal kapatma/ açma

CZ Vypnutí/ zapnutí kanálu  
 PL Włączenie / wyłączenie kanału  
 HU Csatorna ki-/ bekapcsolása  
 SK Vypnutie/ zapnutie kanálu  
 SL Vkllop/ izklop kanala  
 EE Kanali välja/ sisselülitamine  
 LV Kanālu izslēgšana/ ieslēgšana  
 LT Kanalo išjungimas/ įjungimas  
 BG Вкл- / изключване на канал  
 RO Conectarea/deconectarea canalului  
 HR Uključivanje/isključivanje kanala  
 RU Выключение/включение канала



DE Solltemperatur einstellen  
 GB Setting the nominal temperature  
 ES Ajuste de la temperatura de referencia  
 FR Réglage de la température de consigne  
 IT Impostazione della temperatura nominale  
 PT Ajuste da temperatura nominal  
 NL Gewenste temperatuur instellen  
 SV Ställ in börtemperatur  
 DK Indstil nominal temperatur  
 FI Ohjelämpötilan asetus  
 GR Ρύθμιση της ονομαστικής θερμοκρασίας  
 TR Nominal sıcaklığın ayarlanması

CZ Nastavení požadované teploty  
 PL Ustawianie temperatury zadanej  
 HU Előírt hőmérséklet megadása  
 SK Nastavenie požadovanej teploty  
 SL Nastavitev želene temperature  
 EE Nimitemperatuuri seadmine  
 LV Vajadzīgās temperatūras iestatīšana  
 LT Nustatytosios temperatūros nustatymas  
 BG Настройка на зададената температура  
 RO Setarea temperaturii nominale  
 HR Namještanje zadane temperature  
 RU Установка заданной температуры

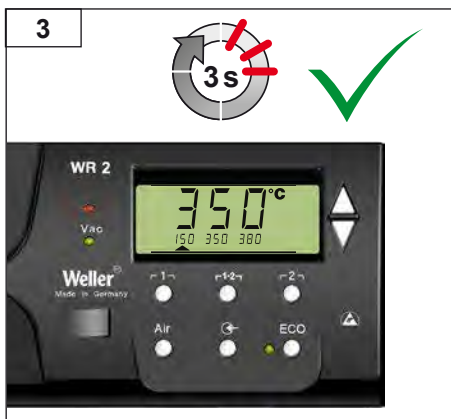
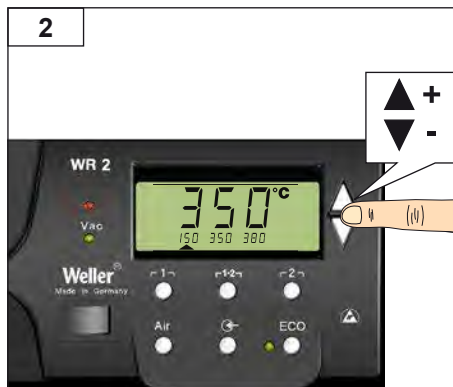
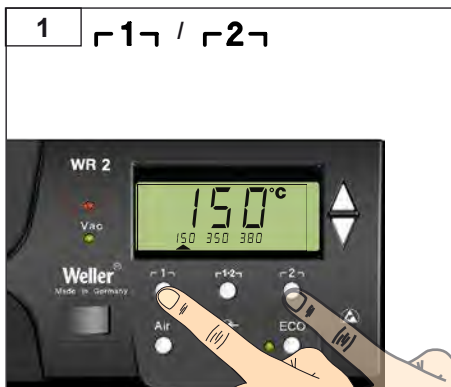

DE Festtemperatur auswählen  
 GB Select fixed temperature  
 ES Seleccionar un valor fijo de temperatura  
 FR Sélectionner la température fixe  
 IT Selezione della temperatura fissa  
 PT Seleccionar temperatura fixa  
 NL Vaste temperatuur selecteren  
 SV Välj fast temperatur  
 DK Vælg fast temperatur  
 FI Kiinteän lämpötilan valinta  
 GR Επιλογή της σταθερής θερμοκρασίας  
 TR Sabit sıcaklık seçilmesi

CZ Volba pevné teploty  
 PL Wybór stałej temperatury  
 HU Rögzített hőmérséklet kiválasztása  
 SK Zvoľte do pamäte fixnú teplotu  
 SL Izbira stalne temperature  
 EE Püsitemperatuuri valimine  
 LV Fiksētās temperatūras izvēle  
 LT Nustatytosios temperatūros parinktis  
 BG Избор на непроменлива температура  
 RO Selectarea temperaturii fixe  
 HR Odabir fiksne temperature  
 RU Выбор фиксированной температуры

1 1 / 2



2



3A



3B



3C



DE Festtemperatur einstellen und speichern  
 GB Set and save fixed temperature  
 ES Ajustar / guardar un valor fijo de temperatura  
 FR Réglage et mémoriser la température fixe  
 IT Impostazione e memorizzazione della temperatura fissa  
 PT Ajustar e memorizar temperatura fixa  
 NL Vaste temperatuur instellen en opslaan  
 SV Ställ in fast temperatur och spara den  
 DK Indstil og gem fast temperatur  
 FI Kiinteän lämpötilan säätö ja tallennus  
 GR Ρύθμιση / αποθήκευση της σταθερής θερμοκρασίας  
 TR Sabit sıcaklık ayarlanmalıdır / kaydedilmelidir  
 CZ Nastavení a uložení pevné teploty

PL Ustawianie i zapis stałej temperatury  
 HU Rögzített hőmérséklet beállítása / mentése  
 SK Nastavte a uložte do fixnú teplotu  
 SL Nastavitev stalne temperature in shranitev  
 EE Püsitemperatuuri reguleerimine / salvestamine  
 LV Fiksētās temperatūras iestatīšana / saglabāšana  
 LT Nustatytosios temperatūros nustatymas ir išsaugojimas  
 BG Задаване и запаметяване на непроменлива температура  
 RO Setarea și salvarea temperaturii fixe  
 HR Namještanje i spremanje fiksne temperature  
 RU Установка и сохранение фиксированной температуры

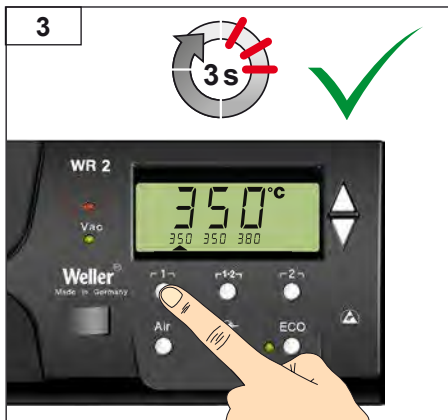
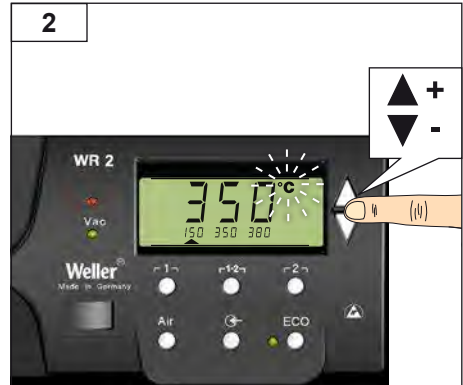
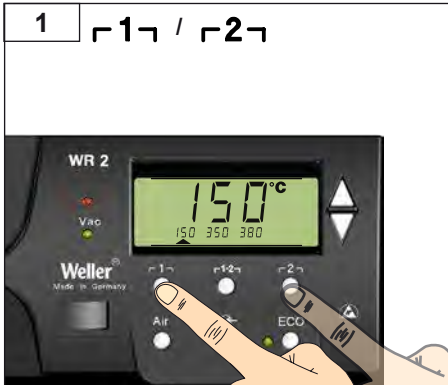

WR 2

DE Kanal auswählen  
 GB Select channel  
 ES Seleccionar canal  
 FR Sélectionner un canal  
 IT Selezione del canale  
 PT Seleccionar o canal  
 NL Kanaal selecteren  
 SV Välj kanal.  
 DK Vælg kanal  
 FI Kanavan valinta  
 GR Επιλογή καναλιού  
 TR Kanal seçimi

CZ Volba kanálu  
 PL Wybór kanału  
 HU Csatorna kiválasztás  
 SK Zvoľte kanál  
 SL Izbira kanala  
 EE kanali valimine  
 LV Kanāla izvēle  
 LT Pasirinkite kanalą  
 BG Изберете канал  
 RO Selectarea canalului  
 HR Odaberite kanal  
 RU Выбор канала



DE Kanal wechseln  
 GB Change channel  
 ES Cambiar de canal  
 FR Changer de canal  
 IT Cambio del canale  
 PT Mudar o canal  
 NL Kanaal wisselen  
 SV Byt kanal  
 DK Skift kanal  
 FI Kanavan vaihto  
 GR Αλλαγή καναλιού  
 TR Kanal değiştirme

CZ Změna kanálu  
 PL Zmiana kanału  
 HU Csatornaváltás  
 SK Zmeňte kanál  
 SL Menjava kanala  
 EE kanali vahetamine  
 LV Kanāla nomaiņa  
 LT Pakeiskite kanalą  
 BG Промяна на канал  
 RO Schimbarea canalului  
 HR Promijenite kanal  
 RU Смена канала





DE Kanal ein-/ ausschalten  
 GB Switching the channel on/ off  
 ES Conexión/ Desconexión del canal  
 FR Activation / désactivation du canal  
 IT Attivazione/ Disattivazione di un canale  
 PT Desligar/ ligar o canal  
 NL Kanaal uit-/ inschakelen  
 SV Koppla in/ ur kanal  
 DK Deaktivering/ aktivering af kanal  
 FI Kanavan pois-/ päällekytkentä  
 GR Απενεργοποίηση/ ενεργοποίηση καναλιού  
 TR Kanal kapatma/ açma

CZ Vypnutí/ zapnutí kanálu  
 PL Włączenie / wyłączenie kanału  
 HU Csatorna ki-/ bekapcsolása  
 SK Vypnutie/ zapnutie kanálu  
 SL Vklop/ izklop kanala  
 EE Kanali välja/ sisselülitamine  
 LV Kanālu izslēgšana/ ieslēgšana  
 LT Kanalo išjungimas / įjungimas  
 BG Вкл- / изключване на канал  
 RO Conectarea/deconectarea canalului  
 HR Uključivanje/isključivanje kanala  
 RU Выключение/включение канала



DE Solltemperatur einstellen  
 GB Setting the nominal temperature  
 ES Ajuste de la temperatura de referencia  
 FR Réglage de la température de consigne  
 IT Impostazione della temperatura nominale  
 PT Ajuste da temperatura nominal  
 NL Gewenste temperatuur instellen  
 SV Ställ in börtemperatur  
 DK Indstil nominal temperatur  
 FI Ohjelämpötilan asetus  
 GR Ρύθμιση της ονομαστικής θερμοκρασίας  
 TR Nominal sıcaklığın ayarlanması

CZ Nastavení požadované teploty  
 PL Ustawianie temperatury zadanej  
 HU Előírt hőmérséklet megadása  
 SK Nastavenie požadovanej teploty  
 SL Nastavitev želene temperature  
 EE Nimitemperatuuri seadmine  
 LV Vajadzīgās temperatūras iestatīšana  
 LT Nustatytosios temperatūros nustatymas  
 BG Настройка на зададената температура  
 RO Setarea temperaturii nominale  
 HR Namještanje zadane temperature  
 RU Установка заданной температуры

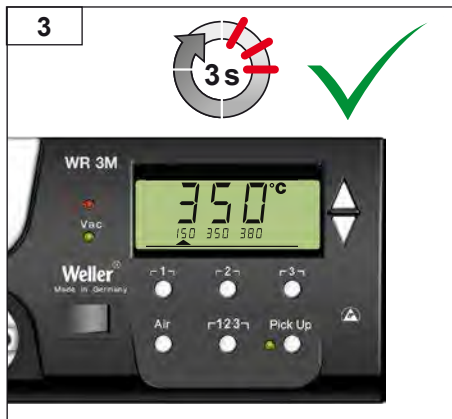
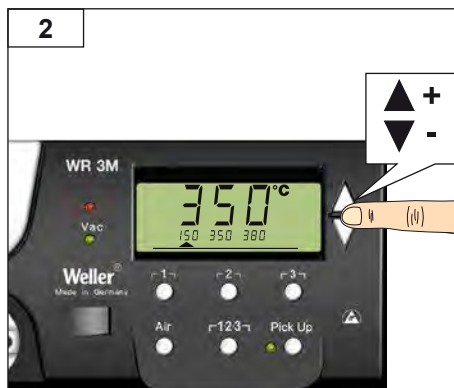
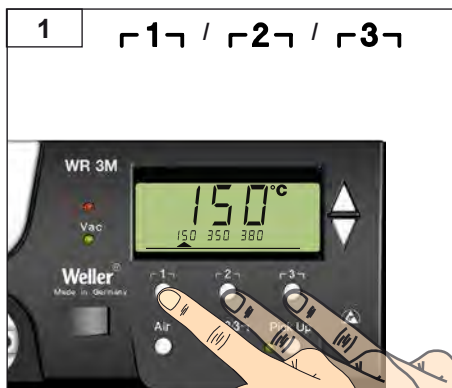

DE Festtemperatur auswählen  
 GB Select fixed temperature  
 ES Seleccionar un valor fijo de temperatura  
 FR Sélectionner la température fixe  
 IT Selezione della temperatura fissa  
 PT Seleccionar temperatura fixa  
 NL Vaste temperatuur selecteren  
 SV Välj fast temperatur  
 DK Vælg fast temperatur  
 FI Kiinteän lämpötilan valinta  
 GR Επιλογή της σταθερής θερμοκρασίας  
 TR Sabit sıcaklık seçimi

CZ Volba pevné teploty  
 PL Wybór stałej temperatury  
 HU Rögzített hőmérséklet kiválasztása  
 SK Zvoľte do pamäte fixnú teplotu  
 SL Izbira stalne temperature  
 EE Püsitemperatuuri valimine  
 LV Fiksētās temperatūras izvēle  
 LT Nustatytosios temperatūros parinktis  
 BG Избор на непроменлива температура  
 RO Selectarea temperaturii fixe  
 HR Odabir fiksne temperature  
 RU Выбор фиксированной температуры

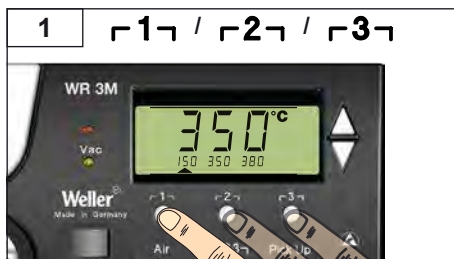

DE Festtemperatur einstellen und speichern  
 GB Set and save fixed temperature  
 ES Ajustar / guardar un valor fijo de temperatura  
 FR Réglage et mémoriser la température fixe  
 IT Impostazione e memorizzazione della temperatura fissa  
 PT Ajustar e memorizar temperatura fixa  
 NL Vaste temperatuur instellen en opslaan  
 SV Ställ in fast temperatur och spara den  
 DK Indstil og gem fast temperatur  
 FI Kiinteän lämpötilan säätö ja tallennus  
 GR Ρύθμιση / αποθήκευση της σταθερής θερμοκρασίας  
 TR Sabit sıcaklık ayarlanmalıdır / kaydedilmelidir  
 CZ Nastavení a uložení pevné teploty

PL Ustawianie i zapis stałej temperatury  
 HU Rögzített hőmérséklet beállítása / mentése  
 SK Nastavte a uložte do fixnú teplotu  
 SL Nastavitev stalne temperature in shranitev  
 EE Püsitemperatuuri reguleerimine / salvestamine  
 LV Fiksētās temperatūras iestatīšana / saglabāšana  
 LT Nustatytosios temperatūros nustatymas ir išsaugojimas  
 BG Задаване и запамятване на непроменлива температура  
 RO Setarea și salvarea temperaturii fixe  
 HR Namještanje i spremanje fiksne temperature  
 RU Установка и сохранение фиксированной температуры

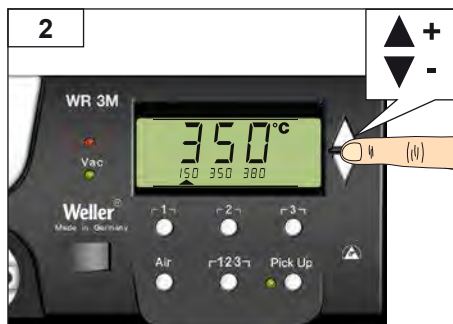
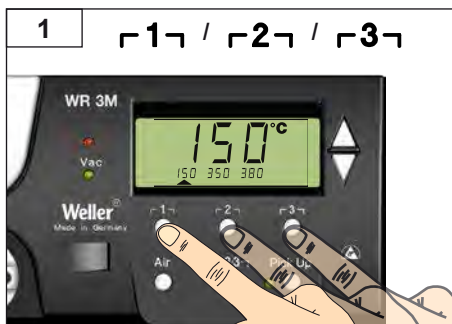

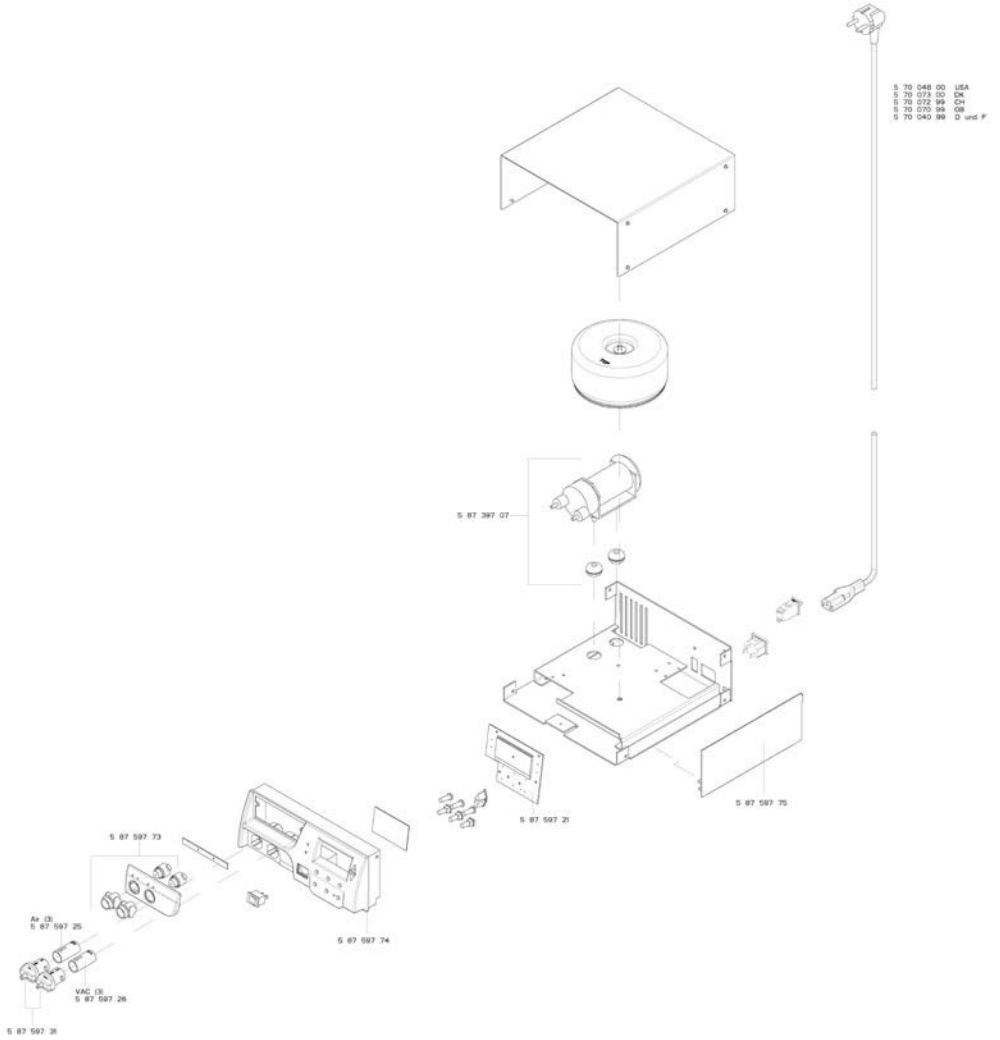

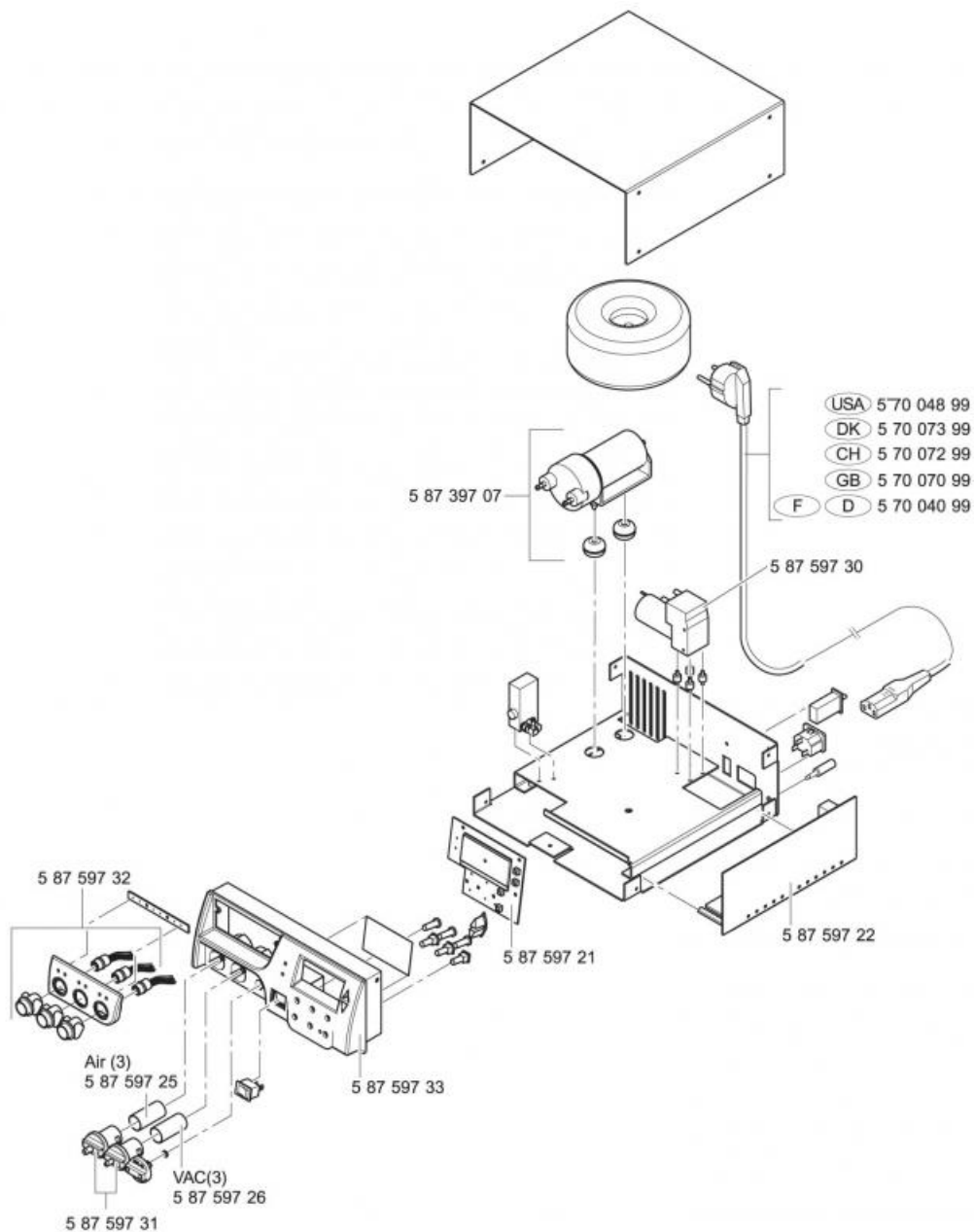

## GERMANY

Weller Tools GmbH  
Carl-Benz-Straße 2  
74354 Besigheim

Tel: +49 (0)7143 580-0  
Fax: +49 (0)7143 580-108

## SWEDEN

Apex Tool Group AB  
Fabriksgatan 4  
531 30 Lidköping

Tel: +46 (0) 510 77 71 720

## AUSTRALIA

Apex Tools  
P.O. Box 366, 519 Nurigong Street  
Albury, N.S.W. 2640  
Australia

Tel: +61 (2)6058-0300  
Fax: +61 (2)6021-7403

## ITALY

Apex Tool S.r.l.  
Viale Europa 80  
20090 Cusago (MI)

Tel: +39 (02)9033101  
Fax: +39 (02)90394231

## SWITZERLAND

Apex Tool Switzerland Sàrl  
Crêt-St-Tombet 15  
2022 Bevaix

Tel: +41 (0) 24 426 12 06  
Fax: +41 (0) 24 425 09 77

## INDIA

Apex Tool Group India Pvt. Ltd.  
Regus business centre  
Level 2, Elegance, Room no. 214  
Mathura Road, Jasola  
New Dehli - 110025

## FRANCE

Apex Tool Group SNC  
25 Avenue Maurice Chevalier  
77832 Ozoir-la-Ferrière

Tel: +33 (0)1.64.43.22.00  
Fax: +33 (0)1.64.43.21.62

## USA

Apex Tool Group, LLC  
14600 York Rd. Suite A  
Sparks, MD 21152

Tel: +1 (800)688-8949  
Fax: +1 (800)234-0472

## CHINA

Apex Tool Group  
A-8 building  
No. 38 Dongsheng Road  
Heqing Industrial Park, Pudong  
Shanghai 201201

Tel: +86 (21)60880288  
Fax: +86 (21)60880289

## GREAT BRITAIN

Apex Tool Group (UK Operations) Ltd  
4th Floor Pennine House  
Washington, Tyne & Wear  
NE37 1LY

Tel: +44 (0) 191 419 7700  
Fax: +44 (0) 191 417 9421

## CANADA

Apex Tools – Canada  
5925 McLaughlin Rd.  
Mississauga, Ontario L5R 1B8

Tel: +1 (905) 501-4785  
Fax: +1 (905) 387-2640

## SOUTH EAST ASIA

Apex Power Tools India Pvt. Ltd.  
Gala No. 1, Plot No. 5  
S. No. 234, 235 & 245  
India land Global Industrial Park  
(Next to Tata Johnson Control)  
Taluka-Mulsi, Phase-I  
Hinjawadi Pune (411057)  
Maharashtra, India  
toolsindia@apextoolgroup.com