



Pushing Performance



# PUSHING EASY INSTALLATION

People | Power | Partnership

**HARTING**  
Sensor actuator boxes

---



# Transforming customer wishes into concrete solutions



The HARTING Technology Group is skilled in the fields of electrical, electronic and optical connection, transmission and networking technology, as well as in manufacturing, mechatronics and software creation. The Group uses these skills to develop customized solutions and products such as connectors for energy and data-transmission/data-networking applications, including, for example, mechanical engineering, rail technology, wind energy plants, factory automation and the telecommunications sector. In addition, HARTING also produces electro-magnetic components for the automobile industry and offers solutions in the field of housing technology and shop systems.

The HARTING Group currently comprises 53 sales companies and production plants worldwide employing a total of about 4,200 staff.



### **We aspire to top performance.**

Connectors ensure functionality. As core elements of electrical and optical termination, connection and infrastructure technologies, they are essential in enabling the modular construction of devices, machines and systems across an extremely wide range of industrial applications. Their reliability is a crucial factor guaranteeing smooth functioning in the manufacturing area, telecommunications, applications in medical technology – in short, connectors are at work in virtually every conceivable application area. Thanks to the ongoing development of our technologies, our customers enjoy investment security and benefit from durable, long-term functionality.

### **Wherever our customers are, we're there.**

Increasing industrialization is creating growing markets that are characterized by widely diverging demands and requirements. What these markets all share in common is the quest for perfection, increasingly efficient processes and reliable technologies. **HARTING** is providing these technologies – in Europe, the Americas and Asia. In order to implement customer requirements in the best possible manner, the **HARTING** professionals at our international subsidiaries engage in up-close, partnership-based interaction with our customers, right from the very early product development phase.

Our on-site staff form the interface to the centrally coordinated development and production departments. In this way, our customers can rely on consistently high, superior product quality – worldwide.

### **Our claim: Pushing Performance.**

**HARTING** provides more than optimally attuned components. In order to offer our customers the best possible solutions, on request **HARTING** contributes a great deal more and is tightly integrated into the value-creation process.

From ready-assembled cables through to control racks or ready-to-go control desks. Our aim is to generate maximum benefit for our customers – with no compromises!

### **Quality creates reliability – and warrants trust.**

The **HARTING** brand stands for superior quality and reliability – worldwide. The standards we set are the result of consistent, stringent quality management that is subject to regular certifications and audits.

EN ISO 9001, the EU Eco-Audit and ISO 14001 are key elements here. We take a proactive stance towards new requirements, which is why **HARTING** is the first company worldwide to have obtained the IRIS quality certificate for rail vehicles.



#### **HARTING technology creates added value for customers.**

Technologies by **HARTING** are at work worldwide. **HARTING**'s presence stands for smoothly functioning systems powered by intelligent connectors, smart infrastructure solutions and sophisticated network systems. Over the course of many years of close, trust-based cooperation with its customers, the **HARTING** Technology Group has become one of the leading specialists globally for connector technology. We offer individual customers specific and innovative solutions that go beyond the basic standard functionalities. These tailored solutions deliver sustained results, ensure investment security and enable customers to achieve significant added value.

#### **Opting for HARTING opens up an innovative, complex world of concepts and ideas.**

In order to develop and produce connectivity and network solutions serving an exceptionally wide range of connector applications in a professional and cost-effective manner, **HARTING** not only commands the full array of conventional tools and basic technologies. Above and beyond these capabilities, **HARTING** is constantly harnessing and refining its broad base of knowledge and experience to create new solutions that also ensure continuity. To secure its lead in know-how, **HARTING** draws on a wealth of sources from its in-house research and applications.

Salient examples of these sources of innovative knowledge include microstructure technologies, 3D design and connection technology,

high-temperature and ultrahigh-frequency applications that are finding use in telecommunications and automation networks, in the automotive industry, or in industrial sensor and actuator applications, RFID and wireless technologies, in addition to packaging and housing made of plastics, aluminium and stainless steel.

#### **HARTING overcomes technological limitations.**

Drawing on the comprehensive resources of the group's technology pool, **HARTING** devises practical solutions for its customers. Whether this involves industrial networks for manufacturing automation, or hybrid interface solutions for wireless telecommunication infrastructures, 3D circuit carriers with microstructures, or cable assemblies for high-temperature applications in the automotive industry - **HARTING** technologies offer not only components, but comprehensive solutions attuned to individual customer requirements and preferences. The range of cost-effective solutions covers ready-to-use cable configurations, completely assembled backplanes and board system carriers, as well as fully wired and tested control panels.

In order to ensure the future-proof design of RF and EMC-compatible interface solutions, the central **HARTING** laboratory (accredited according to DIN EN ISO/IEC 17 025) employs simulation tools, as well as experimental, testing and diagnostics facilities all the way to Industrial computed tomography. In addition to product and process suitability considerations, lifecycle and environmental aspects play a key role in the selection of materials and processes.



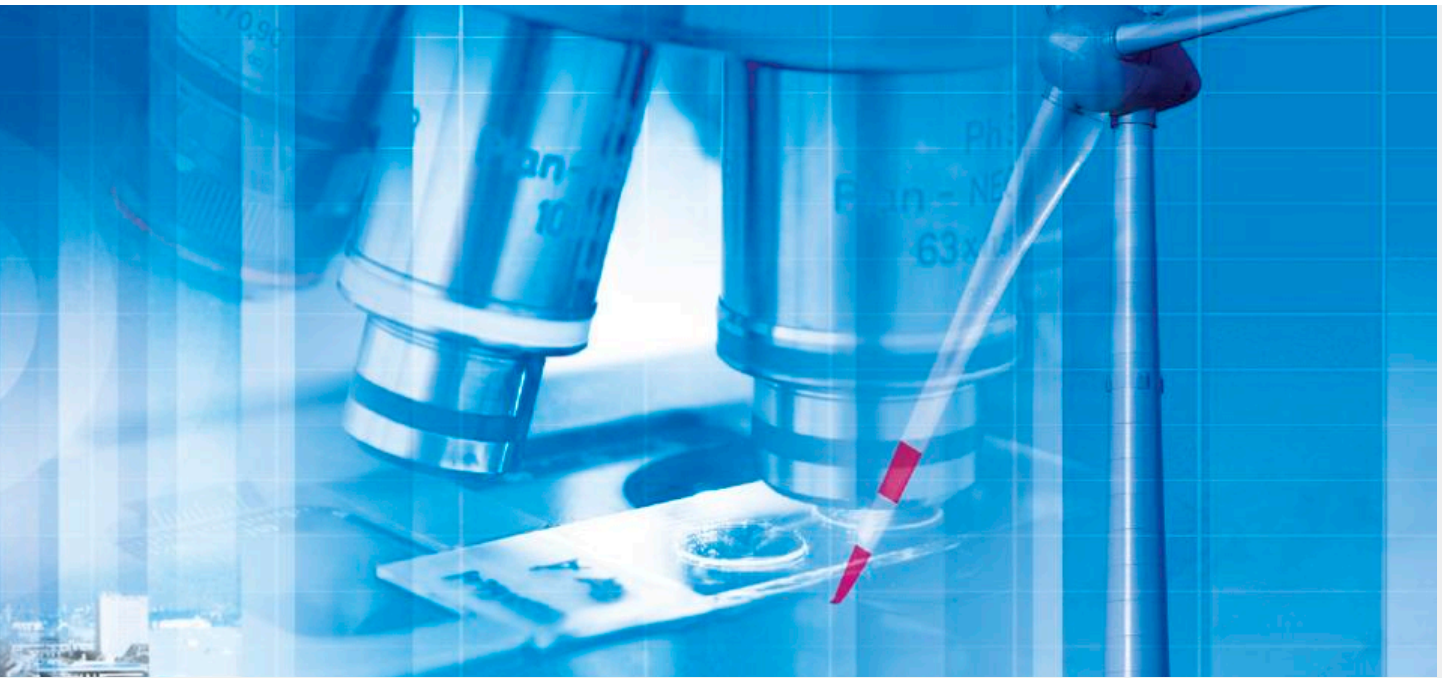

**HARTING's knowledge is practical know-how that generates synergy effects.**

HARTING commands decades of experience with regard to the applications conditions involved in connections in telecommunications, computer, network and medical technologies, as well as industrial automation technologies, e.g. in the mechanical engineering and plant engineering areas, in addition to the power generation industry and the transportation sector. HARTING is

highly conversant with the specific application areas in all of these technology fields. In every solution approach, the key focus is on the application. In this context, uncompromising, superior quality is our hallmark. Every new solution found invariably flows back into the HARTING technology pool, thereby enriching our resources. And every new solution we go on to create will draw on this wealth of resources in order to optimize each and every individual solution. HARTING is synergy in action.

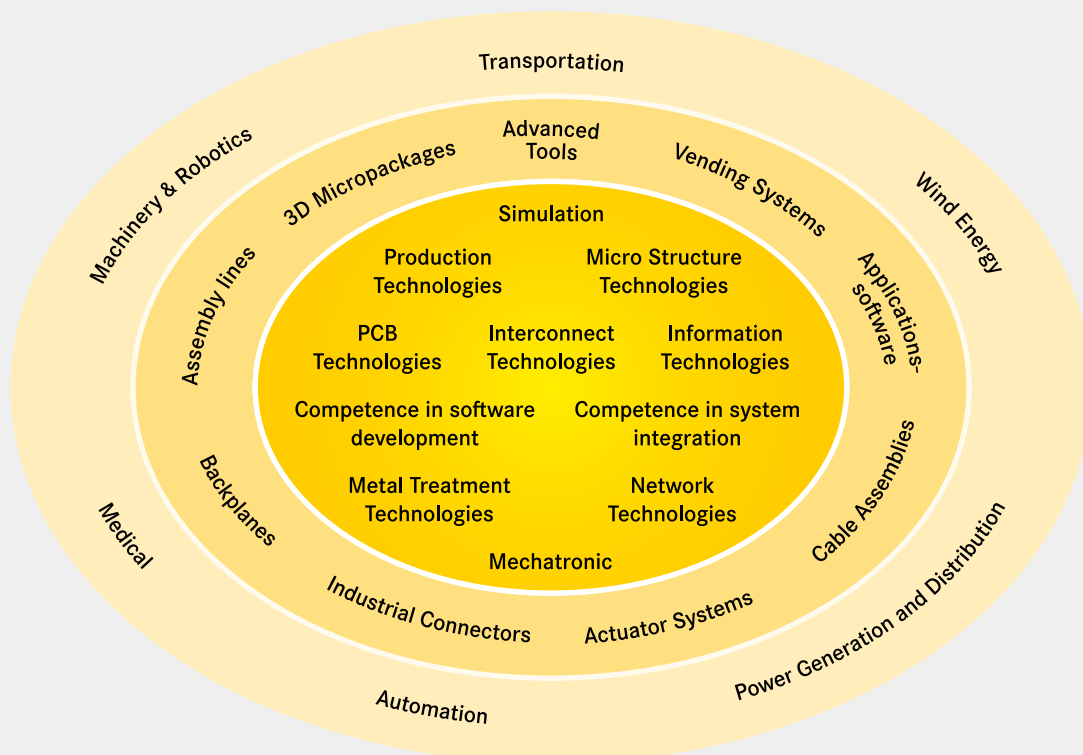



The **HARTING eCatalogue / eShop** can be found on our homepage at [www.HARTING.com](http://www.HARTING.com) or at the direct link [www.eCatalogue.HARTING.com](http://www.eCatalogue.HARTING.com).

The HARTING e-Catalogue is your platform for conveniently selecting individual products as well as configuring complete solutions. Our comprehensive product pages provide you with all necessary technical information and CAD files in various formats for downloading. You may also contact our technical sales department directly.

Find out about **product innovations and news** on the start page of the HARTING e-Catalogue or go directly to [www.product-news.HARTING.com](http://www.product-news.HARTING.com).

Registered users can take advantage of MyHARTING to check on availability or prices, and to place or track their orders. Here, your customized „HARTING history“ provides you with a list of your inquiries, quotations and more.

Sign up now for your free e-Catalogue account at HARTING!

[www.eShop.HARTING.com](http://www.eShop.HARTING.com)

## Contents

Page

### With M12 ports

Connection technology for the master cable

M23 ..... **8**

Pre-assembled cable ..... **9**

Pluggable cable ..... **9**

### With M8 ports

Connection technology for the master cable

M12 or M16 ..... **10**

Pre-assembled cable ..... **11**

### System cables

M12, with A-coding, 4 poles ..... **12**

M12, with A-coding, 5 poles ..... **13**

M8, 3- resp. 4 poles ..... **14**

**Addresses** ..... **15**

HARTING  
sensor actuator boxes  
with M12 ports



## Features

- Available with 4- and 8-port design
- Different connection technologies for master cable
  - M23, pre-assembled or pluggable cable
- 2 LEDs for operating- and status indicator
- Matching M23 and M12 cable assemblies available
- A-coded (4 or 5 poles)
- Passive sensor actuator boxes

## Technical characteristics

Degree of protection	IP68
Number of channels	1 or 2 per port
Rated current	2 A per contact 12 A max. total
Rated voltage	10 - 30 V DC
Temperature range	-20 °C ... +80 °C
Circuit logic	pnp

### Identification

### Part number

### Drawing

### Dimensions in mm

HARTING  
sensor actuator boxes

4 x M12, 4 poles  
1 x M23, 12 poles

09 07 002 0120 0

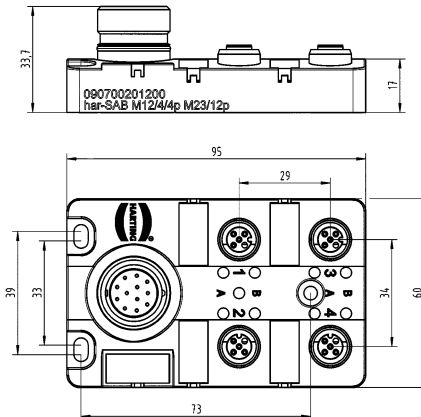

8 x M12, 5 poles  
1 x M23, 19 poles

09 07 003 2220 0

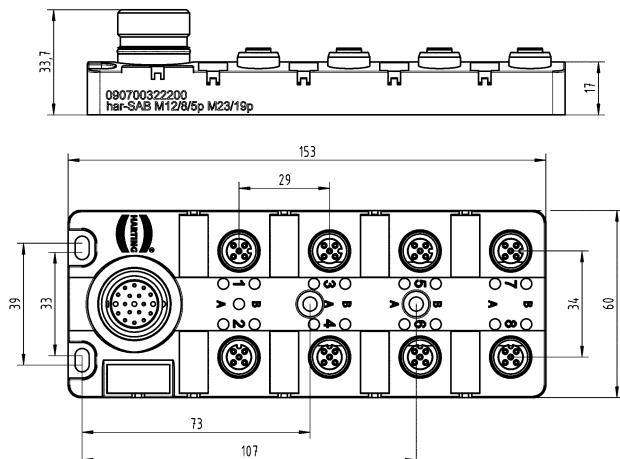



## HARTING sensor actuator boxes with M12 ports



Identification

Part number

Drawing

Dimensions in mm

HARTING sensor actuator boxes

4 x M12, 5 poles pre-assembled cable

09 07 001 0220 0

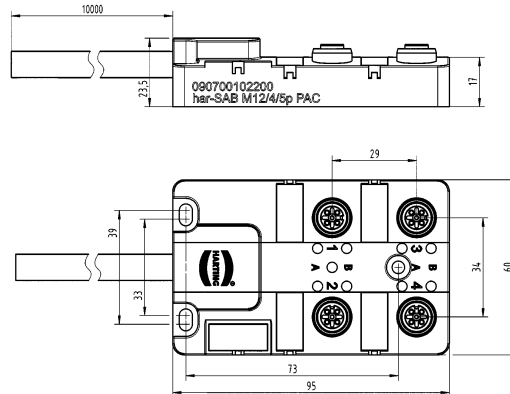

8 x M12, 5 poles pre-assembled cable

09 07 001 2220 0

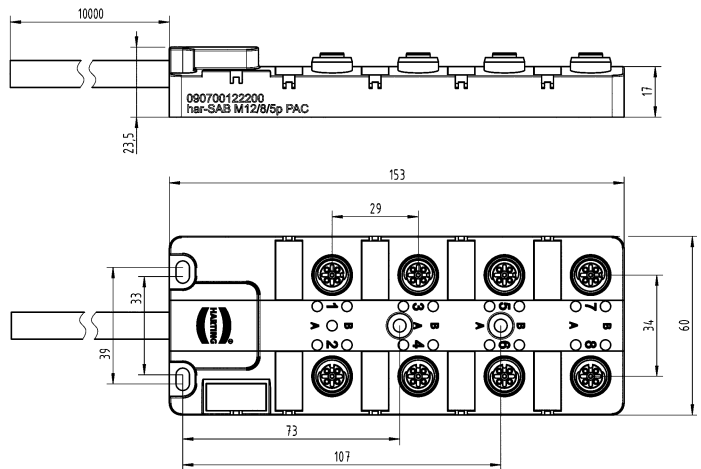

8 x M12, 5 poles pluggable cable

09 07 000 2220 0

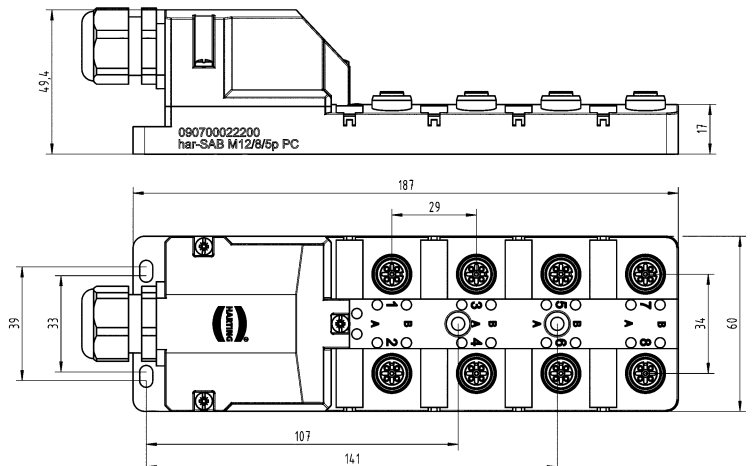



HARTING  
sensor actuator boxes  
with M8 ports

## Features

- Available with 4-, 8- and 10-port design
- Different connection technologies for master cable
  - Pre-assembled cable, M12 or M16
- 2 LEDs for operating- and status indicator
- Matching M8 and M12 cable assemblies available
- A-coded (3 or 4 poles)
- Passive sensor actuator boxes

## Technical characteristics

Degree of protection	IP68	
Number of channels	1 or 2 per port	
Rated current	Pre-assembled / M16	M12, 12 poles
	2 A per contact	1 A per contact
	6 A max. total	1 A max. total
Rated voltage	10 - 30 V DC	
Temperature range	Pre-assembled / M16	M12, 12 poles
	-20 °C ... +80 °C	-25 °C ... +80 °C
Circuit logic	pnp	

Identification	Part number	Drawing	Dimensions in mm
----------------	-------------	---------	------------------

HARTING  
sensor actuator boxes

8 x M8, 3 poles  
1 x M12, 12 poles

09 07 006 2010 0

10 x M8, 3 poles  
1 x M12, 12 poles

09 07 006 3010 0

	a	b
8 ports	101	129.5
10 ports	123	151.5

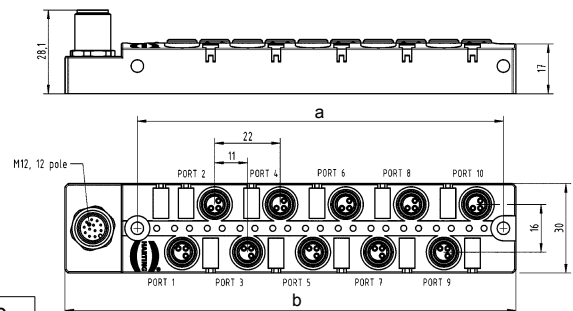

4 x M8, 3 poles  
1 x M16, 14 poles

09 07 004 0010 0

8 x M8, 3 poles  
1 x M16, 14 poles

09 07 004 2010 0

10 x M8, 3 poles  
1 x M16, 14 poles

09 07 004 3010 0

	a	b
4 ports	57	90.4
8 ports	101	134.4
10 ports	123	156.4

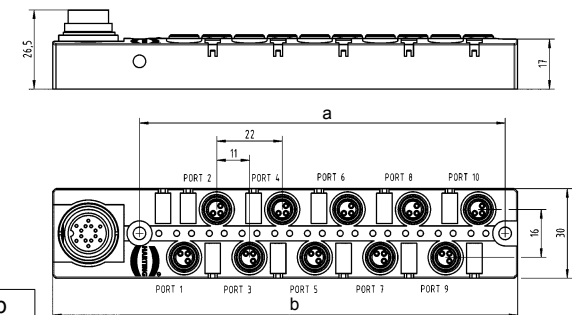



## HARTING sensor actuator boxes with M8 ports

Identification	Part number	Drawing	Dimensions in mm
<p>HARTING sensor actuator boxes</p> <p>4 x M8, 3 poles pre-assembled cable</p>	09 07 001 0010 0		
<p>8 x M8, 3 poles pre-assembled cable</p>	09 07 001 2010 0		
<p>10 x M8, 3 poles pre-assembled cable</p>	09 07 001 3010 0		
<p>4 x M8, 4 poles pre-assembled cable</p>	09 07 001 0110 0		

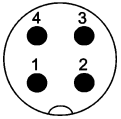

Male, 4 poles

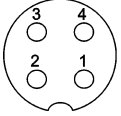

Female, 4 poles



## Part number definition



### Connector 1

- 84 Male straight
- 85 Female straight
- 86 Male angled
- 87 Female angled

### Connector 2

- 00 No connector
- 84 Male straight
- 85 Female straight
- 86 Male angled
- 87 Female angled

### Number of contacts

4 4 poles

### Cable material

- 83 PVC (3 poles)
- 84 PVC (4 poles)
- 90 PUR (3 poles)
- 91 PUR (4 poles)

### Preferred length\*

- 005 0.5 m
- 010 1.0 m
- 015 1.5 m
- 020 2.0 m
- 050 5.0 m
- 075 7.5 m
- 100 10.0 m

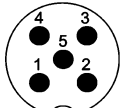

Male, 5 poles

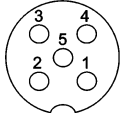

Female, 5 poles



## Part number definition



### Connector 1

- 84 Male straight
- 85 Female straight
- 86 Male angled
- 87 Female angled

### Connector 2

- 00 No connector
- 84 Male straight
- 85 Female straight
- 86 Male angled
- 87 Female angled

### Number of contacts

5 5 poles

### Cable material

- 70 PUR (8 poles)
- 82 PVC (8 poles)
- 85 PVC (5 poles)
- 92 PUR (5 poles)

### Preferred length\*

- 005 0.5 m
- 010 1.0 m
- 015 1.5 m
- 020 2.0 m
- 050 5.0 m
- 075 7.5 m
- 100 10.0 m

\* Other length on request



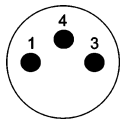

Male, 3 poles

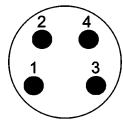

Male, 4 poles

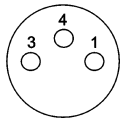

Female, 3 poles

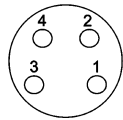

Female, 4 poles



## Part number definition



### Connector 1

- 80 Male straight
- 81 Female straight
- 82 Male angled
- 83 Female angled

### Connector 2

- 00 No connector
- 80 Male straight
- 81 Female straight
- 82 Male angled
- 83 Female angled

### Number of contacts

- 3 3 poles
- 4 4 poles

### Cable material

- 80 PVC (3 poles)
- 81 PVC (4 poles)
- 88 PUR (3 poles)
- 89 PUR (4 poles)

### Preferred length\*

- 005 0.5 m
- 010 1.0 m
- 015 1.5 m
- 020 2.0 m
- 050 5.0 m
- 075 7.5 m
- 100 10.0 m

## Distributors – worldwide



Digi-Key Corporation: [www.digikey.com](http://www.digikey.com)

Farnell: [www.farnell.com](http://www.farnell.com)

FUTURE Electronics: [www.futureelectronics.com](http://www.futureelectronics.com)

Mouser Electronics: [www.mouser.com](http://www.mouser.com)

RS Components: [www.rs-components.com](http://www.rs-components.com)

## Other countries and general contact



HARTING Customised Solutions GmbH & Co. KG

Simeons carré 1  
32427 Minden – Germany

Phone +49 5772 47-0  
Fax +49 5772 47-400

HCS@HARTING.com  
[www.HARTING-customised-solutions.com](http://www.HARTING-customised-solutions.com)



Pushing Performance

**HARTING.com** –  
the gateway to your  
country website.

---

[www.HARTING.ae](http://www.HARTING.ae)  
[www.HARTING.at](http://www.HARTING.at)  
[www.HARTING.com.au](http://www.HARTING.com.au)  
[www.HARTING.be](http://www.HARTING.be)  
[www.HARTING.com.br](http://www.HARTING.com.br)  
[www.HARTING.ca](http://www.HARTING.ca)  
[www.HARTING.ch](http://www.HARTING.ch)  
[www.HARTING.com.cn](http://www.HARTING.com.cn)  
[www.HARTING.cz](http://www.HARTING.cz)  
[www.HARTING.de](http://www.HARTING.de)  
[www.HARTING.dk](http://www.HARTING.dk)  
[www.HARTING.es](http://www.HARTING.es)  
[www.HARTING.fi](http://www.HARTING.fi)  
[www.HARTING.fr](http://www.HARTING.fr)  
[www.HARTING.co.uk](http://www.HARTING.co.uk)  
[www.HARTING.com.hk](http://www.HARTING.com.hk)  
[www.HARTING.hu](http://www.HARTING.hu)  
[www.HARTING.co.in](http://www.HARTING.co.in)  
[www.HARTING.it](http://www.HARTING.it)  
[www.HARTING.co.jp](http://www.HARTING.co.jp)  
[www.HARTING.co.kr](http://www.HARTING.co.kr)  
[www.HARTINGbv.nl](http://www.HARTINGbv.nl)  
[www.HARTING.no](http://www.HARTING.no)  
[www.HARTING.pl](http://www.HARTING.pl)  
[www.HARTING.pt](http://www.HARTING.pt)  
[www.HARTING.ro](http://www.HARTING.ro)  
[www.HARTING.ru](http://www.HARTING.ru)  
[www.HARTING.se](http://www.HARTING.se)  
[www.HARTING.sg](http://www.HARTING.sg)  
[www.HARTING.sk](http://www.HARTING.sk)  
[www.HARTING.com.tr](http://www.HARTING.com.tr)  
[www.HARTING.com.tw](http://www.HARTING.com.tw)  
[www.HARTING-USA.com](http://www.HARTING-USA.com)  
[www.HARTING.co.za](http://www.HARTING.co.za)