

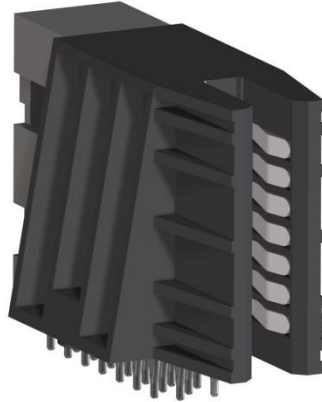

PRODUCT SPECIFICATION

PRODUCT SPECIFICATION EXTREME POWERMASS[®] BUSS BAR CONNECTOR



REVISION: A	ECR/ECN INFORMATION: EC No: UCP2016-3524 DATE: 2014/02/28	TITLE: PRODUCT SPECIFICATION EXTREME POWERMASS BUSS BAR CONNECTOR	SHEET No. 1 of 17
DOCUMENT NUMBER: PS-172201-001	CREATED / REVISED BY: M.BANDURA	CHECKED BY: A. PATEL	APPROVED BY: B. PISZCZOR



PRODUCT SPECIFICATION

Table of Contents

1.0 SCOPE

2.0 PRODUCT DESCRIPTION

- 2.1 Product Name and Series Numbers
- 2.2 Dimensions, Materials, Platings and Markings
- 2.3 Safety Agency Approvals

3.0 APPLICABLE DOCUMENTS AND SPECIFICATIONS

- 3.1. Molex Documents

4.0 ELECTRICAL PERFORMANCE RATINGS

- 4.1 Voltage
- 4.2 Current
- 4.3 Temperature
- 4.4 Durability

5.0 QUALIFICATION

6.0 PERFORMANCE

- 6.1 Electrical Performance
- 6.2 Mechanical Performance
- 6.3 Environmental Performance
- 6.4 Compliant Pin Performance

7.0 PRINTED CIRCUIT BOARD SPECIFICATION

- 7.1 Plated Through Hole Specification
- 7.2 Soldering Profile

8.0 TEST SEQUENCE PER EIA-364-1000.01

9.0 APPENDIX A – ENVIRONMENTAL TEST RESULTS

REVISION: A	ECR/ECN INFORMATION: EC No: UCP2016-3524 DATE: 2014/02/28	TITLE: PRODUCT SPECIFICATION EXTREME POWERMASS BUSS BAR CONNECTOR	SHEET No. 2 of 17
DOCUMENT NUMBER: PS-172201-001	CREATED / REVISED BY: M.BANDURA	CHECKED BY: A. PATEL	APPROVED BY: B. PISZCZOR



PRODUCT SPECIFICATION

1.0 SCOPE

The Extreme Powermass Buss Bar Connector is a right angle receptacle which can attach to a printed circuit board with either press-fit or through-hole solder terminals, and is intended for use with a buss bar type interface.

2.0 PRODUCT DESCRIPTION

2.1 PRODUCT NAMES & SERIES NUMBERS:

This specification covers the performance requirements and test methods for the following products listed by series numbers:

- * 172201-0001 Extreme Powermass Receptacle Assembly, Screw Mount with Press-Fit
- * 172201-0002 Extreme Powermass Receptacle Assembly, Screw Mount with Solder Terminal
- * 172201-0003 Extreme Powermass Receptacle Assembly, Solder Terminal

2.2 DIMENSIONS, MATERIALS, PLATINGS AND MARKINGS

Dimensions: See individual sales drawings.
 Material: RoHs compliant materials (LCP for housings, copper alloy for terminals).
 Plating: Silver on mating surfaces and Tin on the PC tail with nickel underplating overall.

2.3 SAFETY AGENCY APPROVALS

UL File Number: TBD

CSA File Number: TBD

3.0 APPLICABLE DOCUMENTS AND SPECIFICATIONS

Refer to the appropriate sales drawings and other sections of this specification for the necessary referenced documents and specifications.

3.1 MOLEX DRAWINGS

- 3.1.1 SD-172201-0001 Receptacle Assembly Drawing
- 3.1.2 SD-172201-0002 Receptacle Assembly Drawing
- 3.1.3 AS 172201-001 Application Specification

REVISION: A	ECR/ECN INFORMATION: EC No: UCP2016-3524 DATE: 2014/02/28	TITLE: PRODUCT SPECIFICATION EXTREME POWERMASS BUSS BAR CONNECTOR	SHEET No. 3 of 17
DOCUMENT NUMBER: PS-172201-001	CREATED / REVISED BY: M.BANDURA	CHECKED BY: A. PATEL	APPROVED BY: B. PISZCZOR



PRODUCT SPECIFICATION

4.0 RATINGS

4.1 VOLTAGE

UL/CSA: 600 VAC

Connector Rating per UL-1977

Connector voltage rating meets the connector approval level defined by UL 1977, Sect. 11 for spacing per table 11.1. Example: 1.2 mm spacing for a voltage rating of 250 volt or less, and 3.2 mm spacing for a voltage rating of more than 250 volts.

Exception taken for spacing less than those specified are permitted, if the device complies with the requirements in the dielectric voltage withstanding test per Sect. 17. of UL 1977.

Application Voltage Guideline

For application voltage requirements, please refer to UL-60950 or other standards. Creepage & Clearance also needs to be determined based upon pad/trace locations on the pcb.

4.2 CURRENT **

180 Amps

** Current rating is application dependent. Above rating is provided as a guideline only. Appropriate de-rating is required per ambient conditions, copper weight of PCB, gross heating from adjacent modules/components, and other factors that influence connector performance.

REVISION: A	ECR/ECN INFORMATION: EC No: UCP2016-3524 DATE: 2014/02/28	TITLE: PRODUCT SPECIFICATION EXTREME POWERMASS BUSS BAR CONNECTOR	SHEET No. 4 of 17
DOCUMENT NUMBER: PS-172201-001	CREATED / REVISED BY: M.BANDURA	CHECKED BY: A. PATEL	APPROVED BY: B. PISZCZOR



PRODUCT SPECIFICATION

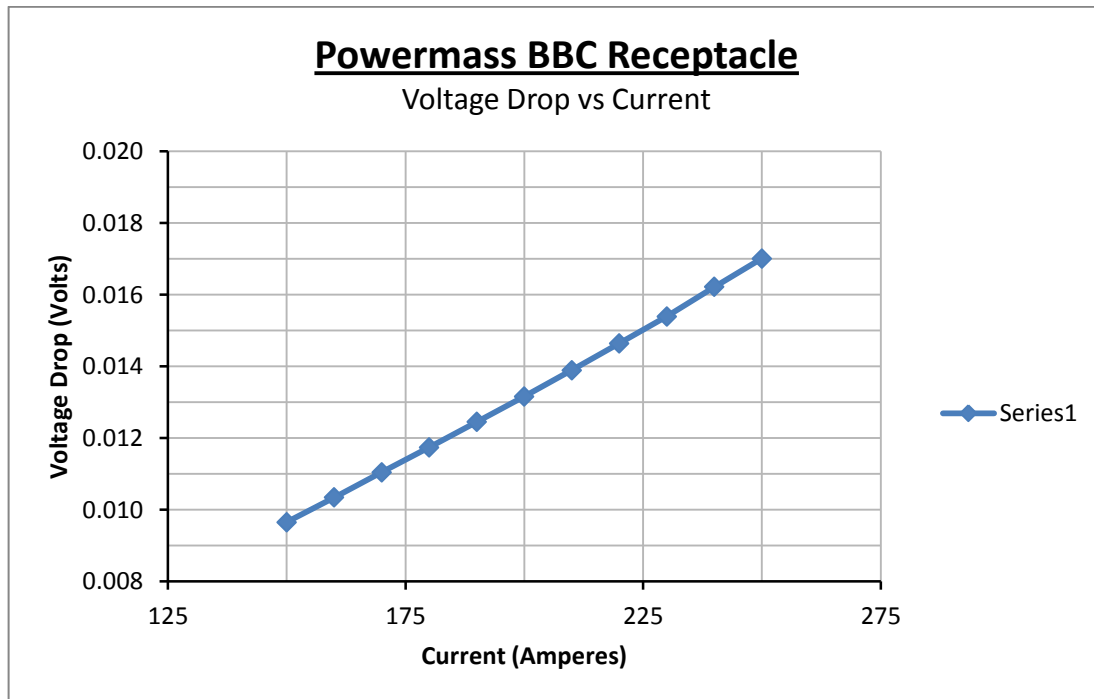
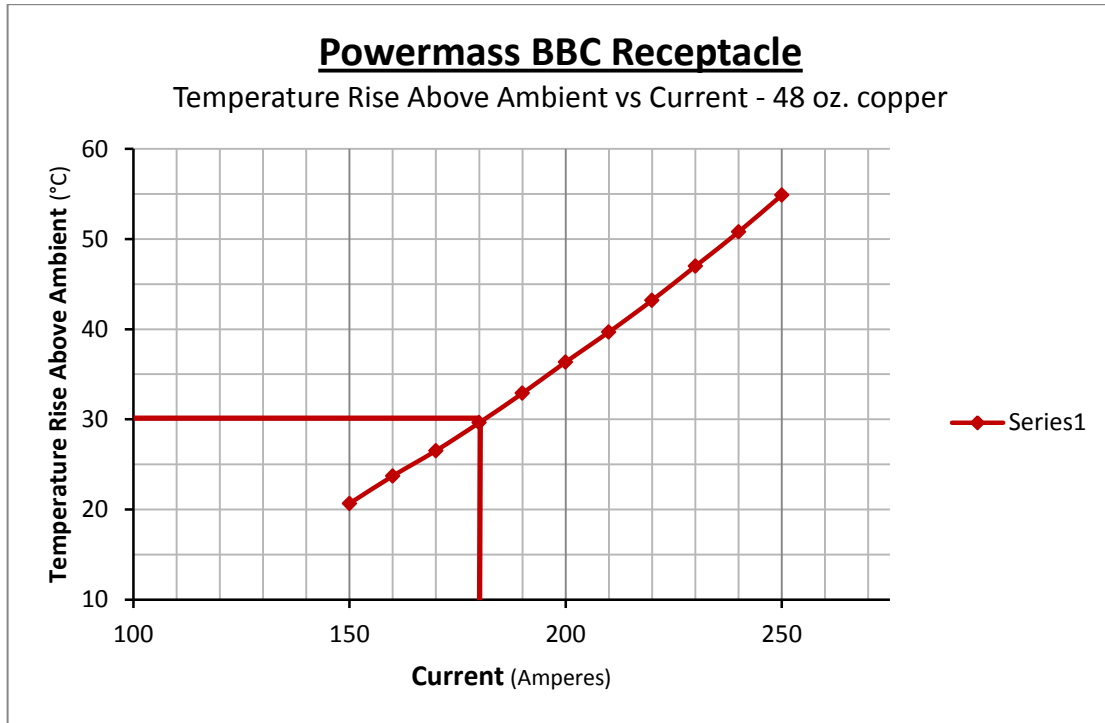

REVISION: A	ECR/ECN INFORMATION: EC No: UCP2016-3524 DATE: 2014/02/28	TITLE: PRODUCT SPECIFICATION EXTREME POWERMASS BUSS BAR CONNECTOR	SHEET No. 5 of 17
DOCUMENT NUMBER: PS-172201-001	CREATED / REVISED BY: M.BANDURA	CHECKED BY: A. PATEL	APPROVED BY: B. PISZCZOR



PRODUCT SPECIFICATION

4.3 TEMPERATURE

Temperature life tested per EIA 364-17 Method A for 180 hrs@105° per table-8 to meet field temperature of 65° C for 7 years life. See Sect. 8.1for detailed test sequence of EIA-364-1000.01, Group I.

Operating: -40°C to +105°C (including T-Rise from applied current)
Non-operating: -40°C to +105°C

4.4 DURABILITY

25 cycles

5.0 QUALIFICATION

Laboratory condition and sample selection are in accordance with EIA-364-1000.01.

REVISION: A	ECR/ECN INFORMATION: EC No: UCP2016-3524 DATE: 2014/02/28	TITLE: PRODUCT SPECIFICATION EXTREME POWERMASS BUSS BAR CONNECTOR	SHEET No. 6 of 17
DOCUMENT NUMBER: PS-172201-001	CREATED / REVISED BY: M.BANDURA	CHECKED BY: A. PATEL	APPROVED BY: B. PISZCZOR



PRODUCT SPECIFICATION

6.0 PERFORMANCE

* The values listed below are derived from testing performed under laboratory conditions, using a silver plated buss bar with an environmental barrier. End results may vary depending upon specific application requirements, and the condition of the mating buss bar interface.

6.1 ELECTRICAL PERFORMANCE

DESCRIPTION	TEST CONDITION	REQUIREMENT
INITIAL CONTACT RESISTANCE (LOW LEVEL) (EIA-364-23)	Per EIA-364-23	0.30 milliohm
VOLTAGE DROP (@ RATED CURRENT)	Per EIA-364-70	See Chart on Page 5
INSULATION RESISTANCE	Apply 500 VDC between adjacent terminals or ground. Per EIA-364-21	5,000 megaohms minimum
DIELECTRIC WITHSTANDING VOLTAGE	Apply 1500 VDC for 1 minute between adjacent terminals or ground. Per EIA-364-20	No breakdown
TEMPERATURE RISE	Mate connectors Measure T-Rise @ Rated Current After 96 Hours per EIA-364-70	30 C T-Rise above ambient

REVISION: A	ECR/ECN INFORMATION: EC No: UCP2016-3524 DATE: 2014/02/28	TITLE: PRODUCT SPECIFICATION EXTREME POWERMASS BUSS BAR CONNECTOR	SHEET No. 7 of 17
DOCUMENT NUMBER: PS-172201-001	CREATED / REVISED BY: M.BANDURA	CHECKED BY: A. PATEL	APPROVED BY: B. PISZCZOR



PRODUCT SPECIFICATION

6.2 MECHANICAL PERFORMANCE

ITEM	TEST CONDITION	REQUIREMENT
MATING FORCE, SINGLE CIRCUIT (EIA-364-37)	Mate connectors at a rate of 25 +/- 6 mm per minute.	3000 g (Max Value)
UNMATING FORCE, SINGLE CIRCUIT (EIA-364-37)	Unmate connectors at a rate of 25 +/- 6 mm per minute.	200 g (Min Value)
DURABILITY W/O ENVIRONMENT (EIA-364-09)	Mate connectors 5 cycles at a maximum rate of 10 cycles per minute.	Maximum Change: 0.25 milliohm
CONTACT RETENTION (EIA-364-29)	Axial pullout force on the terminal in the housing at a rate of 25 +/- 6 mm per minute.	225 g (Min Value)
Resistance to heat from soldering rework (for PCB with OSP vias)	Per EIA-364-61, Test Procedure 4 for compliant pin retention force	Meet PCB retention requirement per Sect 6.4 of this spec.

REVISION: A	ECR/ECN INFORMATION: EC No: UCP2016-3524 DATE: 2014/02/28	TITLE: PRODUCT SPECIFICATION EXTREME POWERMASS BUSS BAR CONNECTOR	SHEET No. 8 of 17
DOCUMENT NUMBER: PS-172201-001	CREATED / REVISED BY: M.BANDURA	CHECKED BY: A. PATEL	APPROVED BY: B. PISZCZOR



PRODUCT SPECIFICATION

6.3 ENVIRONMENTAL PERFORMANCE

ITEM	TEST CONDITION	REQUIREMENT
VIBRATION (EIA-364-28)	Mate connectors and vibrate per EIA-364-28 test condition D 15 minutes each axis	Maximum Change: 0.25 milliohm
MECHANICAL SHOCK (EIA-364-27)	Mate connectors and shock at 50 g with 1/2 sine wave (11 milliseconds) shocks in the X, Y, Z axes (18 shocks total)	Maximum Change: 0.25 milliohm
THERMAL SHOCK (EIA-364 TS-1000.01)	Mate connectors, expose to 10 cycles from -55 deg. C to 85 deg. C per EIA-364 TS-1000.01	Maximum Change: 0.25 milliohm
TEMPERATURE LIFE (EIA-364 TS-1000.01)	Mate Connectors, expose to 180 hours at 105 °C Per EIA-364-17 and EIA-364 TS-1000.01	Maximum Change: 0.25 milliohm
CYCLIC TEMPERATURE AND HUMIDITY (EIA-364 TS-1000.01)	Mate connectors: expose to 24 cycles from 25 °C / 80% RH to 65 °C / 50% RH	Maximum Change: 0.25 milliohm
DUST (EIA-364-91)	Unmated 1 hour duration 25 °C / 50% RH dust mass of 9 g/ft ³ at rate of 300 m/min	Maximum Change: 0.25 milliohm
MIXED FLOWING GAS (EIA-364-65)	168 hours unmated, 72 hours mated, per EIA-364-65 Class IIA	Maximum Change: 0.25 milliohm

REVISION: A	ECR/ECN INFORMATION: EC No: UCP2016-3524 DATE: 2014/02/28	TITLE: PRODUCT SPECIFICATION EXTREME POWERMASS BUSS BAR CONNECTOR	SHEET No. 9 of 17
DOCUMENT NUMBER: PS-172201-001	CREATED / REVISED BY: M.BANDURA	CHECKED BY: A. PATEL	APPROVED BY: B. PISZCZOR



PRODUCT SPECIFICATION

6.4 COMPLIANT PIN PERFORMANCE

* When tested with 3.18 mm thick, double sided PCB, with 2.0 Oz. copper. Values may vary with changes in pcb construction.

6.4.1 Tin Plated Thru Hole - Insertion and Withdrawal Force per EIA-364-05 and EIA-364-29.

COMPONENT	TEST CONDITION	REQUIREMENT	
		INSERT.	WITHDR.
Power Receptacle (Single section)	Insert the single compliant section into the PTH, extract the section from the hole after 12 hrs, repeat 2 times (new part in the same hole)	111 N 25 lb MAX.	28 N 6.5 lb MIN.

6.4.2 OSP Plated Thru Hole - Insertion and Withdrawal Force per EIA-364-05 and EIA-364-29.

COMPONENT	TEST CONDITION	REQUIREMENT	
		INSERT.	WITHDR.
Power Receptacle (Single section)	Insert the single compliant section into the PTH, extract the section from the hole after 12 hrs, repeat 2 times (new part in the same hole)	46.3 N 10.4 lb MAX	20.5 N 4.6 lb MIN.

REVISION: A	ECR/ECN INFORMATION: EC No: UCP2016-3524 DATE: 2014/02/28	TITLE: PRODUCT SPECIFICATION EXTREME POWERMASS BUSS BAR CONNECTOR	SHEET No. 10 of 17
DOCUMENT NUMBER: PS-172201-001	CREATED / REVISED BY: M.BANDURA	CHECKED BY: A. PATEL	APPROVED BY: B. PISZCZOR



PRODUCT SPECIFICATION

7.0 PRINTED CIRCUIT BOARD SPECIFICATION

7.1 PLATED THRU HOLE SPECIFICATION

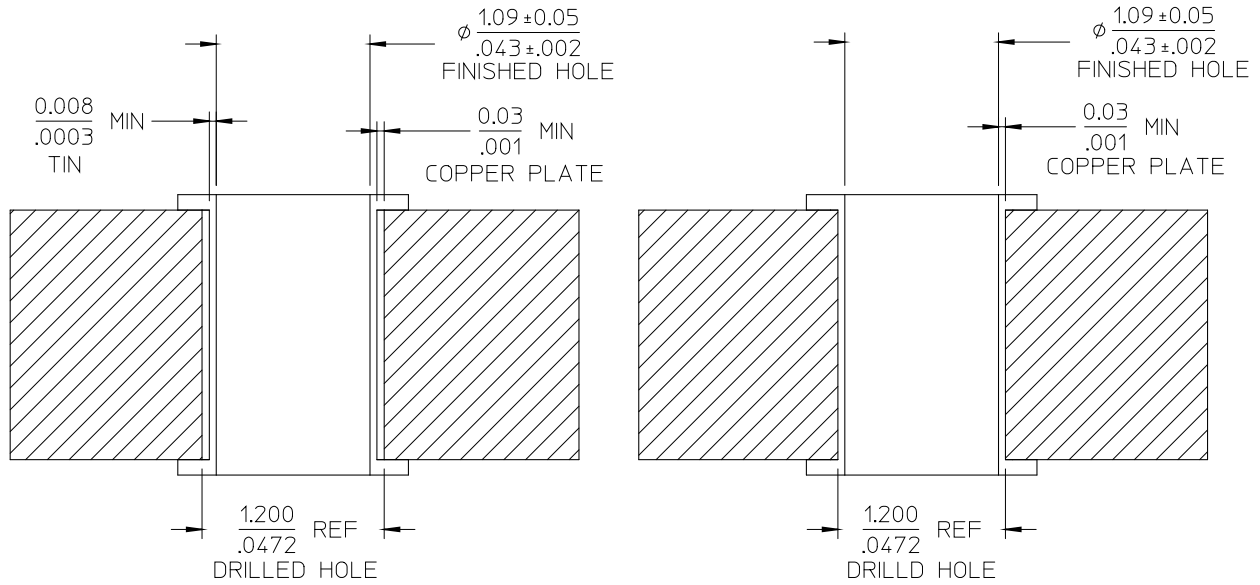

Sn/Cu PLATED HOLES

OSP COATED HOLES

Recommended PCB thickness: 2.38 mm / .093 in. Min. for solder tail.
Recommended PCB thickness: 3.18 mm / .125 in. Min. for press-fit.

PCB Material: FR4

REVISION: A	ECR/ECN INFORMATION: EC No: UCP2016-3524 DATE: 2014/02/28	TITLE: PRODUCT SPECIFICATION EXTREME POWERMASS BUSS BAR CONNECTOR	SHEET No. 11 of 17
DOCUMENT NUMBER: PS-172201-001	CREATED / REVISED BY: M.BANDURA	CHECKED BY: A. PATEL	APPROVED BY: B. PISZCZOR



PRODUCT SPECIFICATION

7.2 SOLDER PROFILE

(This profile is per JEDEC J-STD-020D.1 and it is for guide line only; please see notes for additional information)

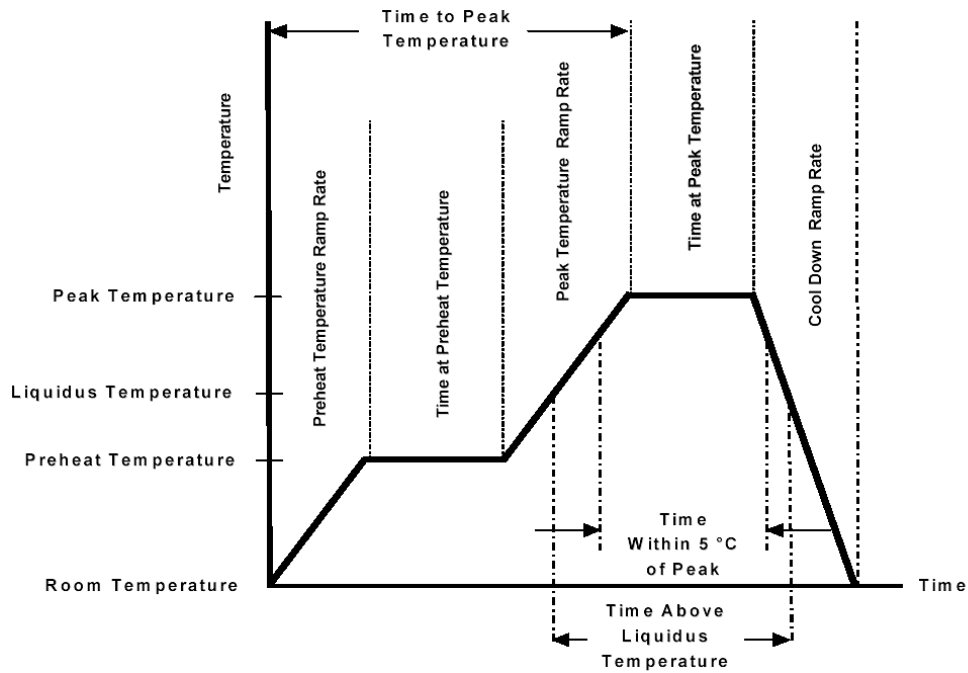

Description	Requirement
Average Ramp Rate	3°C/sec Max
Preheat Temperature	150°C Min to 200°C Max
Preheat Time	60 to 180 sec
Ramp to Peak	3°C/sec Max
Time over Liquids (217°C)	60 to 150 sec
Peak Temperature	260 +0/-5°C
Time within 5°C of Peak	20 to 40 sec
Ramp - Cool Down	6°C/sec Max
Time 25°C to Peak	8 min Max

Notes:

1. Temperature indicated refers to the PCB surface temperature at solder tail area.
2. Connector can withstand up to 3 reflow cycles with a cool-down to room temperature in-between.
3. Actual reflow profile also depends on equipment, solder paste, PCB thickness, and other components on the board. Please consult your solder paste & reflow equipment manufacturer for their recommendations to adopt a suitable process.

REVISION: A	ECR/ECN INFORMATION: EC No: UCP2016-3524 DATE: 2014/02/28	TITLE: PRODUCT SPECIFICATION EXTREME POWERMASS BUSS BAR CONNECTOR	SHEET No. 12 of 17
DOCUMENT NUMBER: PS-172201-001	CREATED / REVISED BY: M.BANDURA	CHECKED BY: A. PATEL	APPROVED BY: B. PISZCZOR



PRODUCT SPECIFICATION

8.0 TEST SEQUENCE

8.1 Reliability Test Sequences (per EIA-364-1000):

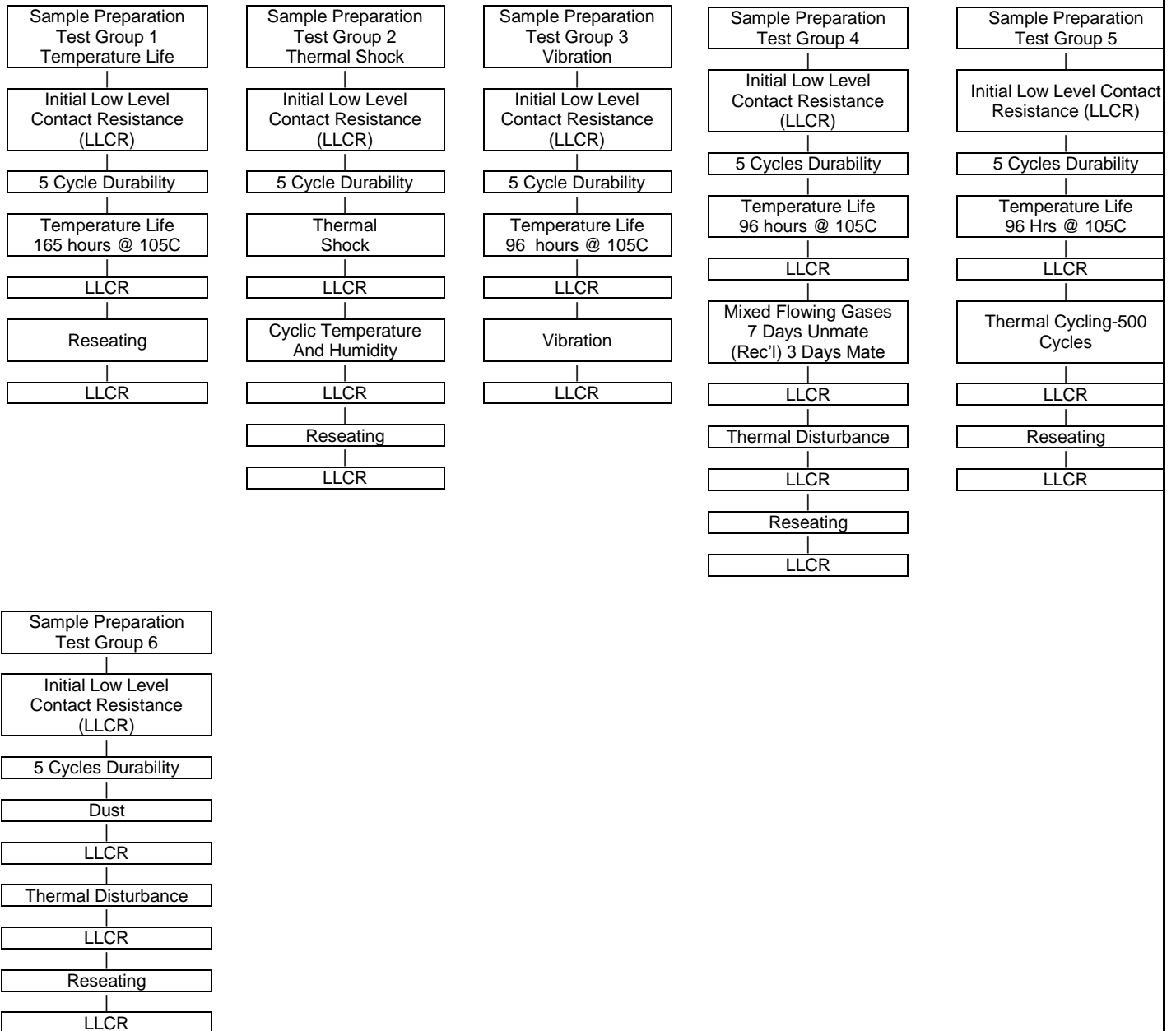

REVISION: A	ECR/ECN INFORMATION: EC No: UCP2016-3524 DATE: 2014/02/28	TITLE: PRODUCT SPECIFICATION EXTREME POWERMASS BUSS BAR CONNECTOR	SHEET No. 13 of 17
DOCUMENT NUMBER: PS-172201-001	CREATED / REVISED BY: M.BANDURA	CHECKED BY: A. PATEL	APPROVED BY: B. PISZCZOR



PRODUCT SPECIFICATION

8.2 Miscellaneous Test Sequences:

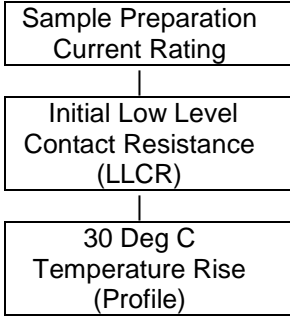

REVISION: A	ECR/ECN INFORMATION: EC No: UCP2016-3524 DATE: 2014/02/28	TITLE: PRODUCT SPECIFICATION EXTREME POWERMASS BUSS BAR CONNECTOR	SHEET No. 14 of 17	
DOCUMENT NUMBER: PS-172201-001		CREATED / REVISED BY: M.BANDURA	CHECKED BY: A. PATEL	APPROVED BY: B. PISZCZOR



PRODUCT SPECIFICATION

APENDIX A ENVIRONMENTAL TEST RESULTS

REVISION: A	ECR/ECN INFORMATION: EC No: UCP2016-3524 DATE: 2014/02/28	TITLE: PRODUCT SPECIFICATION EXTREME POWERMASS BUSS BAR CONNECTOR	SHEET No. 15 of 17
DOCUMENT NUMBER: PS-172201-001	CREATED / REVISED BY: M.BANDURA	CHECKED BY: A. PATEL	APPROVED BY: B. PISZCZOR



PRODUCT SPECIFICATION

EIA-364-1000, Test Group 1				
	Initial (mΩ)	Durability 5X (Δ mΩ)	Temp Life 105C, 165 Hrs (Δ mΩ)	Reseating 3X (Δ mΩ)
Max	0.128	0.017	0.045	0.005
Min	0.101	-0.019	-0.022	-0.032
Avg	0.114	-0.003	0.017	-0.015
N	10	10	10	10
Criteria	-	0.25 mΩ Max	0.25 mΩ Max	0.25 mΩ Max
Result	-	All Pass	All Pass	All Pass

EIA-364-1000, Test Group 2					
	Initial (mΩ)	Durability 5X (Δ mΩ)	Thermal Shock (Δ mΩ)	Cyclic Humidity (Δ mΩ)	Reseating 3X (Δ mΩ)
Max	0.133	0.005	0.014	0.047	0.002
Min	0.100	-0.018	-0.028	-0.029	-0.031
Avg	0.116	-0.005	-0.002	0.002	-0.014
N	10	10	10	10	10
Criteria	-	0.25 mΩ Max	0.25 mΩ Max	0.25 mΩ Max	0.25 mΩ Max
Result	-	All Pass	All Pass	All Pass	All Pass

EIA-364-1000, Test Group 3				
	Initial (mΩ)	Durability 5X (Δ mΩ)	Temp Life 105C, 96 Hrs (Δ mΩ)	Vibration (Δ mΩ)
Max	0.141	0.033	0.049	0.029
Min	0.092	-0.031	0.003	-0.029
Avg	0.116	0.001	0.033	-0.003
N	10	10	10	10
Criteria	-	0.25 mΩ Max	0.25 mΩ Max	0.25 mΩ Max
Result	-	All Pass	All Pass	All Pass

REVISION: A	ECR/ECN INFORMATION: EC No: UCP2016-3524 DATE: 2014/02/28	TITLE: PRODUCT SPECIFICATION EXTREME POWERMASS BUSS BAR CONNECTOR	SHEET No. 16 of 17
DOCUMENT NUMBER: PS-172201-001	CREATED / REVISED BY: M.BANDURA	CHECKED BY: A. PATEL	APPROVED BY: B. PISZCZOR



PRODUCT SPECIFICATION

EIA-364-1000, Test Group 4							
	Initial (mΩ)	Durability 5X (Δ mΩ)	Temp Life 105C, 96 Hrs (Δ mΩ)	MFG-7 Day Unmated (Δ mΩ)	MFG-3 Day Mated (Δ mΩ)	Thermal Disturbance (Δ mΩ)	Reseating 3X (Δ mΩ)
Max		0.029	0.036	0.023	0.005	0.004	0.000
Min		-0.016	-0.027	-0.023	-0.029	-0.041	-0.036
Avg		0.002	0.009	-0.004	-0.013	-0.022	-0.019
N		30	30	30	30	30.000	30
Criteria	-	0.25 mΩ Max	0.25 mΩ Max	0.25 mΩ Max	0.25 mΩ Max	0.25 mΩ Max	0.25 mΩ Max
Result	-	All Pass	All Pass	All Pass	All Pass	All Pass	All Pass

EIA-364-1000, Test Group 5					
	Initial (mΩ)	Durability 5X (Δ mΩ)	Temp Life 105C, 96 Hrs (Δ mΩ)	Thermal Cycling (Δ mΩ)	Reseating 3X (Δ mΩ)
Max	0.134	0.025	0.055	0.061	0.029
Min	0.096	-0.016	-0.029	-0.026	0.000
Avg	0.112	0.003	0.006	0.012	0.010
N	10	10	10	10	10
Criteria	-	0.25 mΩ Max	0.25 mΩ Max	0.25 mΩ Max	0.25 mΩ Max
Result	-	All Pass	All Pass	All Pass	All Pass

EIA-364-1000, Test Group 6					
	Initial (mΩ)	Durability 5X (Δ mΩ)	Dust (Δ mΩ)	Thermal Disturbance (Δ mΩ)	Reseating 3X (Δ mΩ)
Max	0.126	0.013	0.009	0.039	-0.009
Min	0.090	-0.027	-0.019	-0.024	-0.023
Avg	0.110	0.000	-0.007	-0.005	-0.015
N	10	10	10	10	10
Criteria	-	0.25 mΩ Max	0.25 mΩ Max	0.25 mΩ Max	0.25 mΩ Max
Result	-	All Pass	All Pass	All Pass	All Pass

REVISION: A	ECR/ECN INFORMATION: EC No: UCP2016-3524 DATE: 2014/02/28	TITLE: PRODUCT SPECIFICATION EXTREME POWERMASS BUSS BAR CONNECTOR	SHEET No. 17 of 17
DOCUMENT NUMBER: PS-172201-001	CREATED / REVISED BY: M.BANDURA	CHECKED BY: A. PATEL	APPROVED BY: B. PISZCZOR