

# **UNISTAR SB-NET**

120-230V 50/60Hz  
800VA to 3kVA

# **USER MANUAL**

Staco Energy is highly specialized in the development and production of uninterruptible power systems (UPS). The UPS's of this series are high quality products, carefully designed and manufactured to ensure optimum performance.

No reproduction of any part of this manual, even partial, is permitted without the authorization of Staco Energy Products Company. The Staco Energy Products Company reserves the right to modify the product described herein, in order to improve it, at any time and without notice.

301 Gaddis Boulevard • Dayton, Ohio 45403  
U.S. Toll Free 866-261-1191  
(937) 253-1191 • Fax: (937) 253-1723  
Web site: [www.stacoenergy.com](http://www.stacoenergy.com)

*Thank you for choosing our product.*

## Table of Contents

|   |    |
|---|----|
| 1. Important Safety Warnings .....              | 1  |
| 1.1 Transportation .....                        | 1  |
| 1.2 Preparation.....                            | 1  |
| 1.3 Installation .....                          | 1  |
| 1.4 Operation .....                             | 1  |
| 1.5 Maintenance, Service and Faults.....        | 2  |
| 1.6 WEEE.....                                   | 3  |
| 1.7 FCC (120V Models).....                      | 3  |
| 1.8 EMC (230V Models) .....                     | 3  |
| 2. Installation and setup .....                 | 4  |
| 2.1 120V Models Rear panel view .....           | 4  |
| 2.1.1 800VA/1.1KVA/1.5KVA.....                  | 4  |
| 2.1.2 2 kVA .....                               | 4  |
| 2.1.3 3 kVA .....                               | 4  |
| 2.2 230V Models Rear panel view .....           | 5  |
| 2.2.1 800VA/1.1KVA/1.5KVA.....                  | 5  |
| 2.2.2 2 kVA .....                               | 5  |
| 2.2.3 3 kVA .....                               | 5  |
| 2.3 Operating principle .....                   | 6  |
| 2.4 Install the UPS.....                        | 6  |
| 2.4.1 Rack-mount Installation .....             | 7  |
| 2.4.2 Tower Installation .....                  | 7  |
| 2.5 Setup the UPS.....                          | 8  |
| 2.6 Battery Replacement.....                    | 10 |
| 2.7 Battery Kit Assembly (option).....          | 11 |
| 3. Operation .....                              | 13 |
| 3.1 Button operation .....                      | 13 |
| 3.2 LCD Panel.....                              | 14 |
| 3.3 Audible Alarm .....                         | 15 |
| 3.4 LCD display wordings index .....            | 15 |
| 3.5 UPS Settings .....                          | 16 |
| 3.6 Steps for setting programmable outlet ..... | 18 |
| 3.7 Operating Mode Description .....            | 19 |
| 3.8 Faults Reference Code.....                  | 20 |
| 3.9 Warning indicator.....                      | 20 |
| 4. Troubleshooting.....                         | 21 |
| 5. Storage and Maintenance .....                | 22 |
| 5.1 Operation .....                             | 22 |
| 5.2 Storage.....                                | 22 |
| 6. UPS Specifications.....                      | 23 |
| 6.1 120V Models .....                           | 23 |
| 6.2 230V Models .....                           | 24 |

# 1. Important Safety Warnings

Please comply with all warnings and operating instructions in this manual strictly. Save this manual properly and read carefully the following instructions before installing the unit. Do not operate this unit before reading through all safety information and operating instructions carefully

## 1.1 Transportation

Please transport the UPS system only in the original package to protect against shock and impact.

## 1.2 Preparation

- Condensation may occur if the UPS system is moved directly from cold to warm environment. The UPS system must be absolutely dry before being installed. Please allow at least two hours for the UPS system to acclimate the environment.
- Do not install the UPS system near water or in moist environments.
- Do not install the UPS system where it would be exposed to direct sunlight or near heater.
- Do not block ventilation holes in the UPS housing.

## 1.3 Installation

- Do not connect appliances or devices which would overload the UPS system (e.g. laser printers) to the UPS output sockets.
- Place cables in such a way that no one can step on or trip over them.
- Do not connect domestic appliances such as hair dryers to UPS output sockets.
- The UPS can be operated by any individuals with no previous experience.
- Connect the UPS system only to an earthed shockproof outlet which must be easily accessible and close to the UPS system.
- Please use only VDE-tested, CE-marked mains cable (e.g. the mains cable of your computer) to connect the UPS system to the building wiring outlet (shockproof outlet).
- Please use only VDE-tested, CE-marked power cables to connect the loads to the UPS system.
- When installing the equipment, it should ensure that the sum of the leakage current of the UPS and the connected devices does not exceed 3.5mA.
- Temperature Rating - Units are considered acceptable for use in a maximum ambient of 40°C (104°F).
- For PLUGGABLE EQUIPMENT, the socket-outlet shall be installed near the equipment and shall be easily accessible.
- CAUTION: The unit is heavy. Lifting the unit requires a minimum of two people.
- Check if there is a protection device against over current and short circuit in the upstream of the UPS system. The recommended protection spec is 11A for 800VA~1100VA, 15A for 1.5KVA, 20A for LV 2KVA and 30A for 2.5~3KVA with a B or C trip curve.

## 1.4 Operation

- Do not disconnect the mains cable on the UPS system or the building wiring outlet (shockproof socket outlet) during operations since this would cancel the protective earthing of the UPS system and of all connected loads.
- The UPS system features its own, internal current source (batteries). The UPS output sockets or output terminals block may be electrically live even if the UPS system is not connected to the building wiring outlet.
- In order to fully disconnect the UPS system, first press the OFF/Enter button to disconnect the mains.
- Prevent no fluids or other foreign objects from inside of the UPS system.
- The EPO, RS-232 and USB circuits are an IEC 60950-1 safety extra low voltage (SELV) circuit. This circuit must be separated from any hazardous voltage circuits by reinforced insulation.

## 1.5 Maintenance, Service and Faults

- The UPS system operates with hazardous voltages. Repairs may be carried out only by qualified maintenance personnel.
- **Caution** - risk of electric shock. Even after the unit is disconnected from the mains (building wiring outlet), components inside the UPS system are still connected to the battery and electrically live and dangerous.
- Before carrying out any kind of service and/or maintenance, disconnect the batteries and verify that no current is present and no hazardous voltage exists in the terminals of high capability capacitor such as BUS-capacitors.
- To avoid electrical shock, turn off the unit and unplug it from the AC power source before servicing the battery
- Only persons who are adequately familiar with batteries and with the required precautionary measures may replace batteries and supervise operations. Unauthorized persons must be kept well away from the batteries.
- **Caution** - risk of electric shock. The battery circuit is not isolated from the input voltage. Hazardous voltages may occur between the battery terminals and the ground. Before touching, please verify that no voltage is present!
- Batteries may cause electric shock and have a high short-circuit current. Please take the precautionary measures specified below and any other measures necessary when working with batteries:
  - – remove wristwatches, rings and other metal objects
  - – use only tools with insulated grips and handles.
- When changing batteries, install the same number and same type of batteries.
- Do not attempt to dispose of batteries by burning them. This could cause battery explosion.
- Do not open or destroy batteries. Escaping electrolyte can cause injury to the skin and eyes. It may be toxic.
- When replacing batteries, use the same type and number of batteries or battery packs.

| Manufacture   | Type         | Rated           |
|---|--------------|-----------------|
| Toplite (Guangzhou) Technology Battery Co Ltd (MH29104) | NPW45-12     | 12 V dc, 9.0 Ah |
|   | UXW460-12    | 12 V dc, 9.0 Ah |
|   | NPW36-12     | 12 V dc, 7.2 Ah |
|   | UXW360-12    | 12 V dc, 7.2 Ah |
|   | NPW45-12 FR  | 12 V dc, 7.0 Ah |
|   | UXW460-12/FR | 12 V dc, 7.0 Ah |
|   | NPW36-12 FR  | 12 V dc, 7.0 Ah |
|   | UXW360-12/FR | 12 V dc, 7.0 Ah |
| CSB Battery Co Ltd (MH14533)                            | UPS 12460 F2 | 12 V dc, 9.0 Ah |
|   | UPS 12360 6  | 12 V dc, 6.5 Ah |
|   | UPS 12360 7  | 12 V dc, 6.5 Ah |
|   | HR 1234W     | 12 V dc, 8.5 Ah |
|   | HR 1234W FR  | 12 V dc, 8.5 Ah |
| Yuasa Battery (Guangdong) Co Ltd (MH29616)              | NPW45-12     | 12 V dc, 8.0 Ah |
|   | NPW45-12FR   | 12 V dc, 8.0 Ah |

- Do not dismantle the UPS system.
- A battery can may cause a risk of electrical shock and high short-circuit current. The following precautions should be observed when working on batteries:
  - a) Remove watches, rings, or other metal objects.
  - b) Use tools with insulated handles.
  - c) Wear rubber gloves and boots.
  - d) Do not lay tools or metal parts on top of batteries.
  - e) Disconnect charging source prior to connecting or disconnecting battery terminals.
  - f) Determine if battery is inadvertently grounded. If inadvertently grounded, remove source from ground. Contact with any part of a grounded battery can result in electrical shock. The likelihood of such shock can be reduced if such grounds are removed during installation and maintenance.

## 1.6 WEEE

### Information for Protection of the Equipment

UPS SERVICING – This UPS and batteries makes use of components dangerous for the environment (electronic cards, electronic components). The components removed must be taken to specialized collection and disposal centers.



Notice to European Union Customers: Disposal of Old Appliances – This product has been supplied from an environmentally aware manufacturer that complies with Waste Electrical and Electronic Equipment (WEEE) Directive 2002/96/CE. The "crossed-out wheeled bin" symbol at right is placed on this product to encourage you to recycle wherever possible. Please be environmentally responsible and recycle this product through your recycling facility at its end of life. Do not dispose of this product as unsorted municipal waste. Follow local municipal waste ordinances for proper disposal provisions to reduce the environmental impact to waste electrical and electronic equipment (WEEE)

## 1.7 FCC (120V Models)

**NOTE:** This equipment has been tested and found to comply with the limits for a Class A digital device, pursuant to part 15 of the FCC Rules. These limits are designed to provide reasonable protection against harmful interference when the equipment is operated in a commercial environment. This equipment generates, uses, and can radiate radio frequency energy and, if not installed and used in accordance with the instruction manual, may cause harmful interference to radio communications. Operation of this equipment in a residential area is likely to cause harmful interference in which case the user will be required to correct the interference at his own expense.

## 1.8 EMC (230V Models)

**WARNING:** This is a category C2 UPS product. In a residential environment, this product may cause radio interference, in which case the user may be required to take additional measures.

## 2. Installation and setup

**NOTE:** Before installation, please inspect the unit. Be sure that nothing inside the package is damaged. Please keep the original package in a safe place for future use.

### 2.1 120V Models Rear panel view

#### 2.1.1 800VA/1.1KVA/1.5KVA

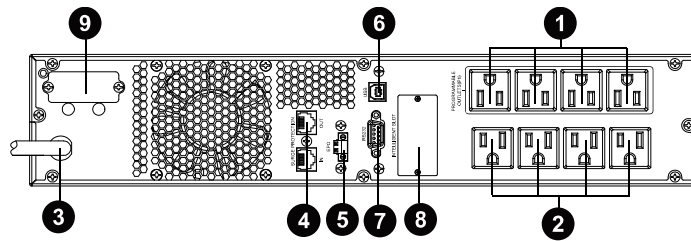

#### 2.1.2 2 kVA

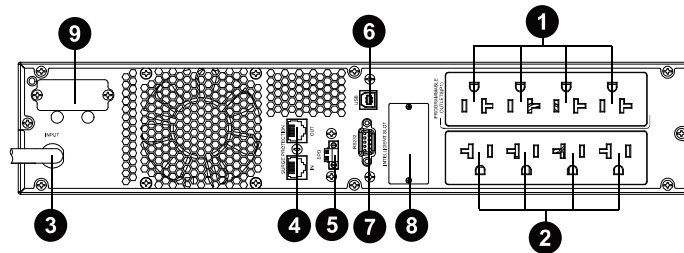

#### 2.1.3 3 kVA

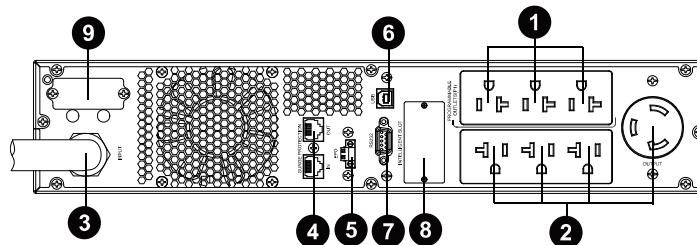

1. Programmable outlets: connect to non-critical loads.
2. Output receptacles: connect to mission-critical loads.
3. AC input
4. Network/Fax/Modem surge protection
5. Emergency power off function connector (EPO)
6. USB communication port
7. RS-232 communication port
8. SNMP intelligent slot
9. External battery connector

| kVA                 | Input Connection | Output Connection |
|---------------------|------------------|-------------------|
| 800VA/1.1KVA/1.5KVA | 5-15P            | 5-15R             |
| 2kVA                | 5-20P            | 5-20R             |
| 3 kVA               | L5-30P           | 5-20R & L5-30R    |

Table 1 – Input/Output Connections

## 2.2 230V Models Rear panel view

### 2.2.1 800VA/1.1KVA/1.5KVA

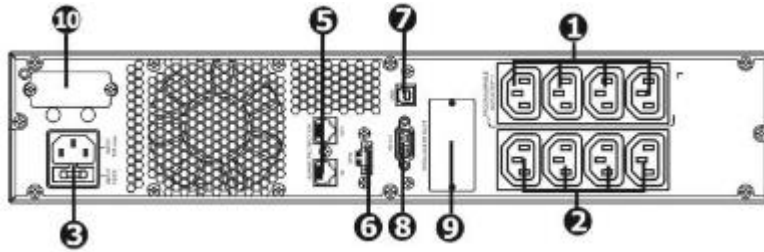

### 2.2.2 2 kVA

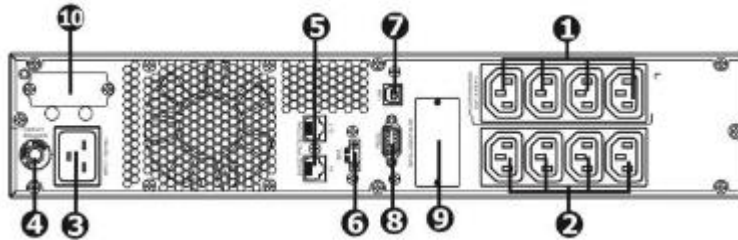

### 2.2.3 3 kVA

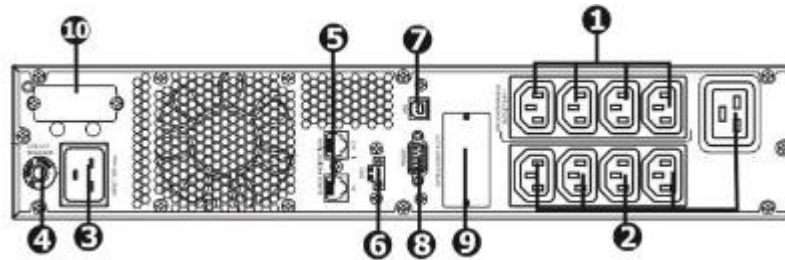

1. Programmable outlets: connect to non-critical loads.
2. Output receptacles: connect to mission-critical loads.
3. AC input
4. Network/Fax/Modem surge protection
5. Emergency power off function connector (EPO)
6. USB communication port
7. RS-232 communication port
8. SNMP intelligent slot
9. External battery connector

| kVA                 | UPS Input Connection | UPS Output Connection   | Input Cord Connector |
|---------------------|----------------------|-------------------------|----------------------|
| 800VA/1.1KVA/1.5KVA | IEC320-C14           | IEC320-C13              | C13                  |
| 2kVA                | IEC320-C20           | IEC320-C13              | C19                  |
| 3kVA                | IEC320-C20           | IEC320-C13 & IEC320-C19 | C19                  |

Table 2 – Input/Output Connections



## 2.3 Operating principle

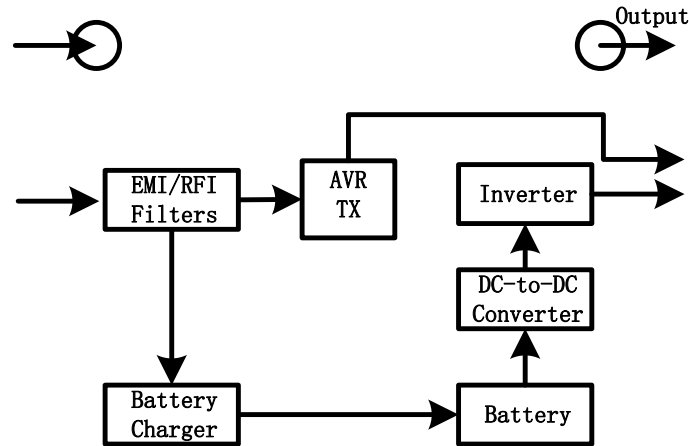

The UPS is composed of mains input, EMI/RFI Filters, Inverter, Battery charger, DC-to-DC converter, battery, AVR TX and UPS output

## 2.4 Install the UPS

For safety consideration, the UPS is shipped out from factory without connecting battery wires. Before installing the UPS, please follow the below steps to re-connect battery wire.

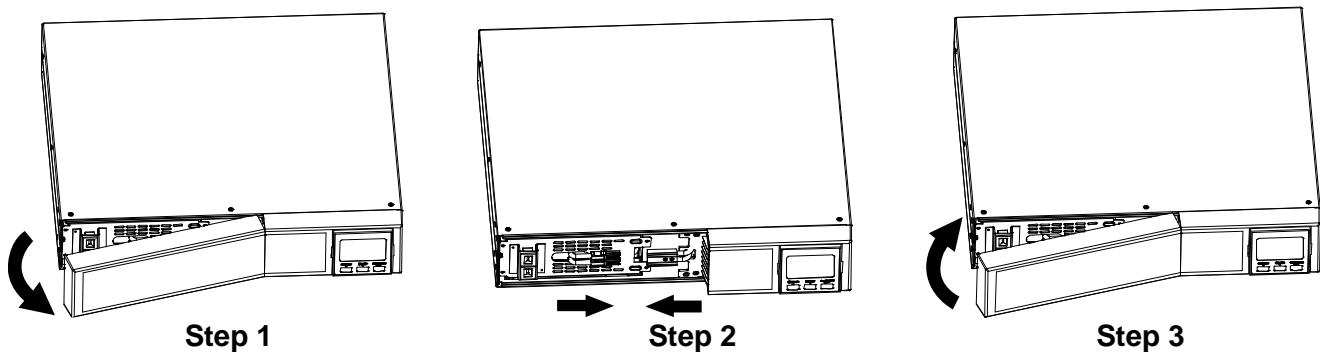

**Step 1:** Remove front panel.

**Step 2:** Remove battery panel and re-connect battery wire.

**Step 3:** Put battery panel and cover back to the unit.

This UPS can be either displayed on the desk or mounted in the 19" rack chassis. Please choose proper installation to position this UPS.

### 2.4.1 Rack-mount Installation

**CAUTION** – Do NOT use the mounting brackets to lift the unit. The mounting brackets are only for securing the unit to the rack.

#### Install UPS alone

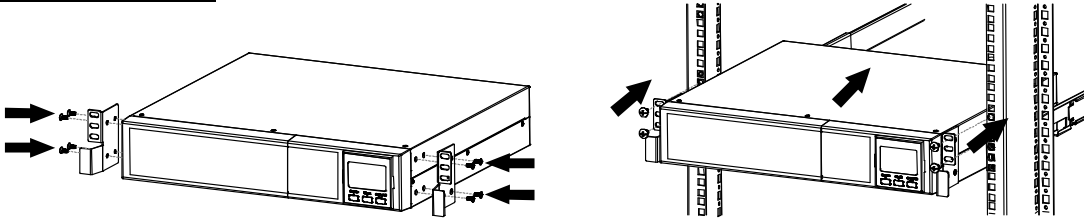

#### Install UPS and external battery

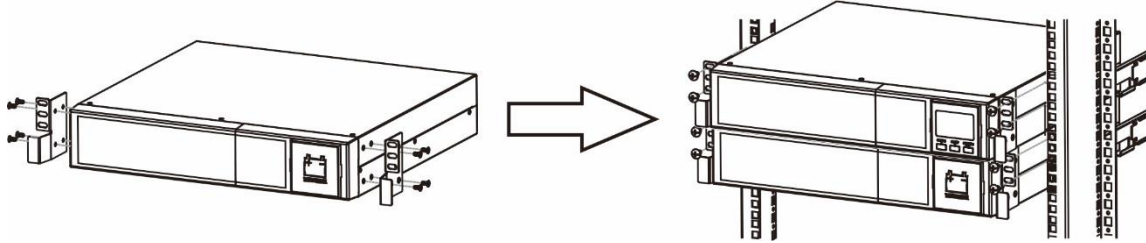

### 2.4.2 Tower Installation

#### Install UPS alone

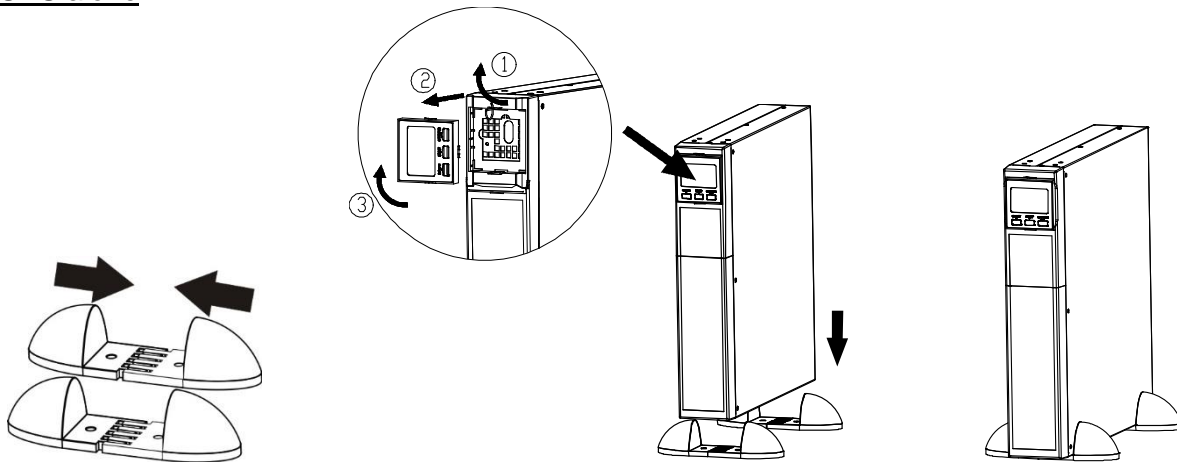

#### Install UPS and external battery

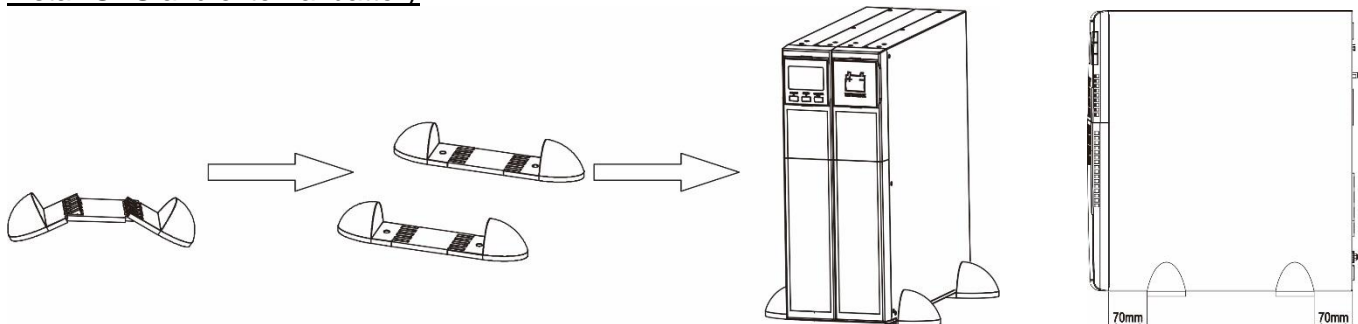

**NOTE:** When installing the UPS or battery pack with feet, keep 2.76in distance from the edge of the unit.

## 2.5 Setup the UPS

### Step 1: UPS input connection

Plug the UPS into a two-pole, three-wire, grounded receptacle only. Avoid using extension cords.

### Step 2: UPS output connection

There two kinds of outputs: programmable outlets and general outlets. Connect non-critical devices to the programmable outlets and critical devices to the general outlets. During power failure, you may extend the backup time to critical devices by setting shorter backup time for non-critical devices.

### Step 3: Communication connection

Communication port:

**USB port**



**RS-232 port**

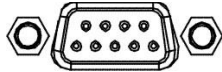

**Intelligent slot**

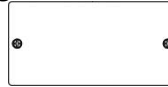

To allow for unattended UPS shutdown/start-up and status monitoring, connect one end of the communication cable to the USB/RS-232 port and the other end to the communication port of your PC. With the monitoring software installed, you can perform these operations:

- Remote Shutdown of UPS
- Send shutdown commands to remote computers
- Remotely set parameters of the UPS
- Set-up the number of battery strings connected
- Set-up voltage and frequency ranges

See manual for monitoring software for details.

The UPS is equipped with an intelligent slot perfect for either a SNMP or an AS400 card. Installing either a SNMP or AS400 card in the UPS will provide advanced communication and monitoring options.

**NOTE: USB port and RS-232 port can't work at the same time.**

### Step 4: Network connection

**Network/Fax/Phone surge port**



Connect a single modem/phone/fax line into surge-protected “IN” outlet on the back panel of the UPS unit. Connect from “OUT” outlet to the equipment with another modem/fax/phone line cable.

### Step 5: Disable and enable EPO function

This UPS is equipped with EPO function. By default, the UPS is delivered from factory with Pin 1 and pin 2 closed (a metal plate is connected to Pin 1 and Pin2) for UPS normal operation. To activate EPO function, remove two screws on EPO port and green connector will be removed.

**Note:** The EPO function logic can be set up via LCD setting. Please refer to program 16 in UPS setting for the details.

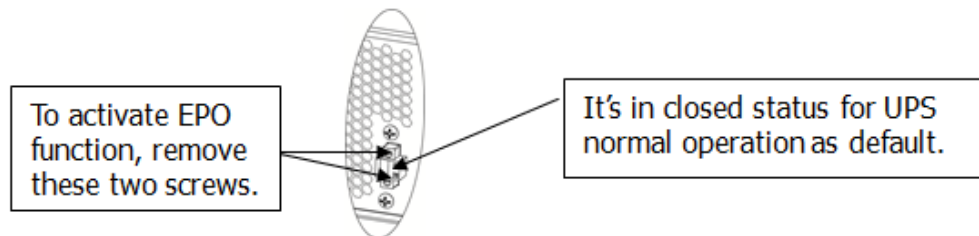

### Step 6: External battery connection

Connect one end of external battery cable to UPS unit and the other end to battery pack. See below chart for detailed connection.

**CAUTION:** Connection to External Battery shall be installed by SERVICE PERSONNEL only.

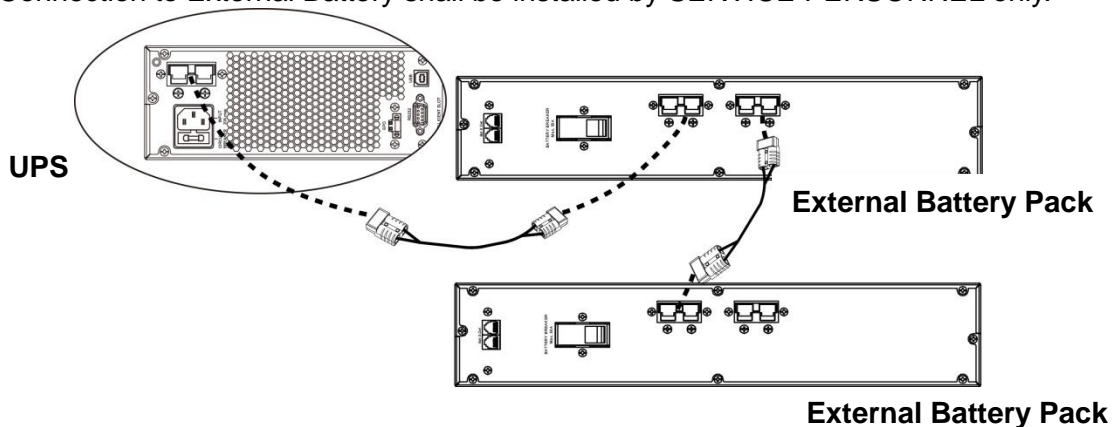

**CAUTION** – Risk of fire hazard.

### Step 7: Turn on the UPS

Press the ON/Mute button on the front panel for two seconds to power on the UPS.

**Note:** The battery charges fully during the first five hours of normal operation. Do not expect full battery run capability during this initial charge period.

### Step 8: Install software

Install UPS monitoring software to fully configure UPS shutdown. Follow the steps below to download and install monitoring software:

1. Go to the website <http://www.power-software-download.com>
2. Click ViewPower software icon and then choose your required OS to download the software.
3. Follow the on-screen instructions to install the software.
4. When your computer restarts, the monitoring software will appear as an orange plug icon located in the system tray, near the clock.

## 2.6 Battery Replacement

**NOTICE:** This UPS is equipped with internal batteries and only service personnel can replace the batteries.

**CAUTION!!** Consider all warnings, cautions, and notes before replacing batteries.

**NOTE:** Upon battery disconnection, equipment is not protected from power outages.

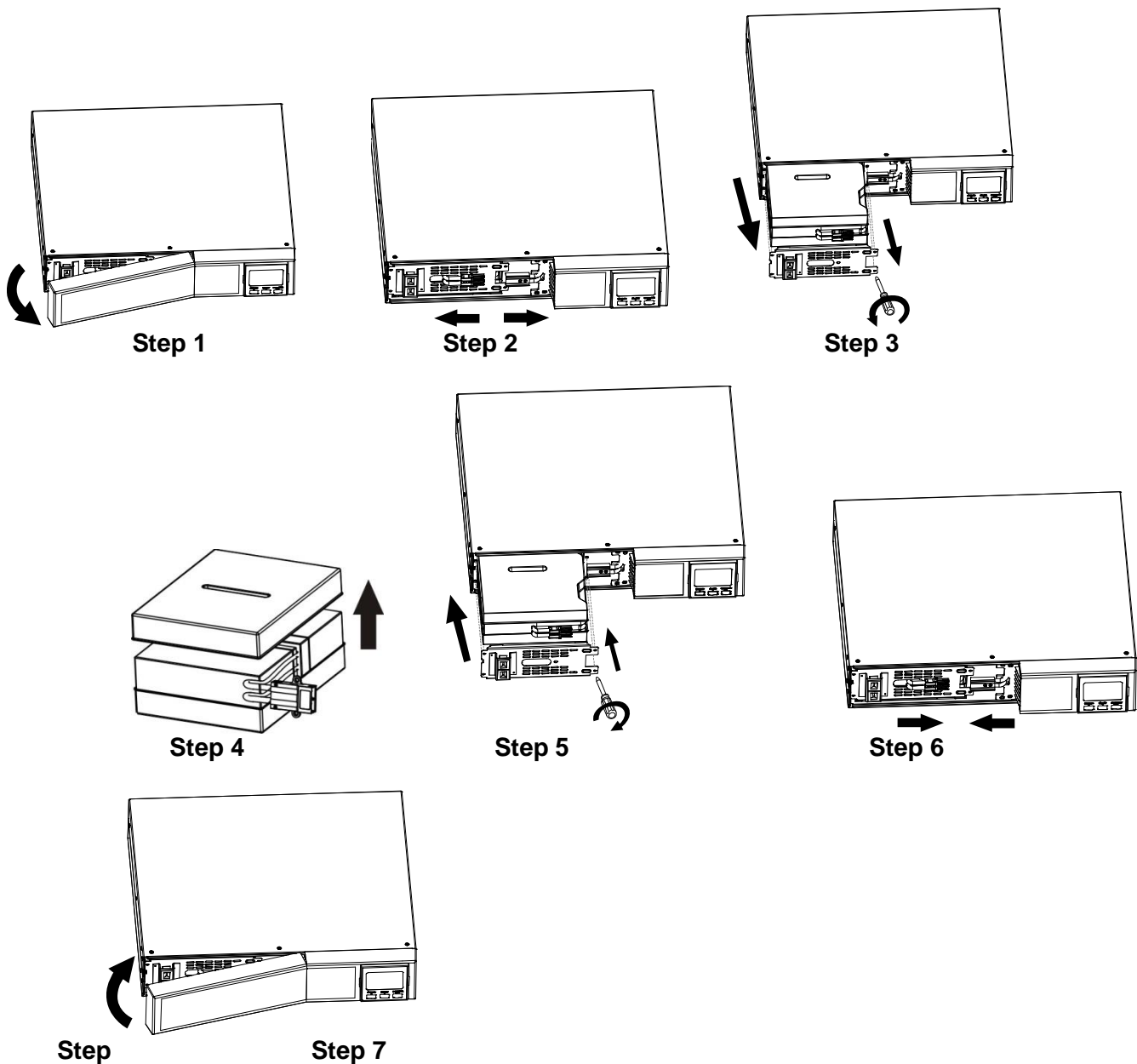

**Step 1:** Remove front panel.

**Step 2:** Disconnect battery wire and remove battery panel.

**Step 3:** Pull out the battery box.

**Step 4:** Remove the top cover of battery box and replace the inside batteries.

**Step 5:** After replacing the batteries, put the battery box back to original location and screw in tightly.

**Step 6:** Re-connect the battery wire and screw battery panel back on the unit.

**Step 7:** Put the front panel back on the unit.

## 2.7 Battery Kit Assembly (option)

**NOTICE:** Replacement battery pack comes fully assembled from the factory. Consult factory for details.

### 2-battery kit – 800-1000VA

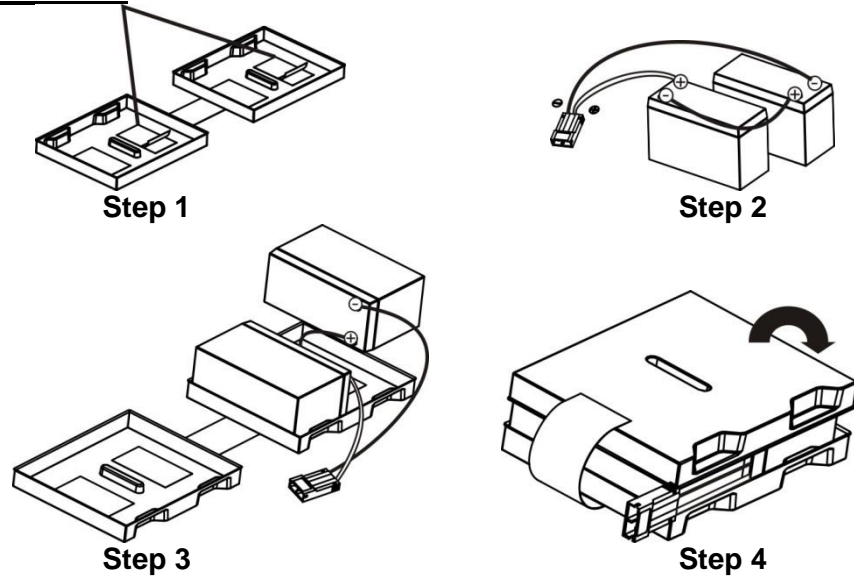

**Step 1:** Remove adhesive tapes.

**Step 2:** Connect all battery terminals by following below picture.

**Step 3:** Put assembled battery packs on one side of plastic shells.

**Step 4:** Cover the other side of plastic shell as shown below. Then, battery kit is fully assembled.

### 4-battery kit – 1.5-2kVA

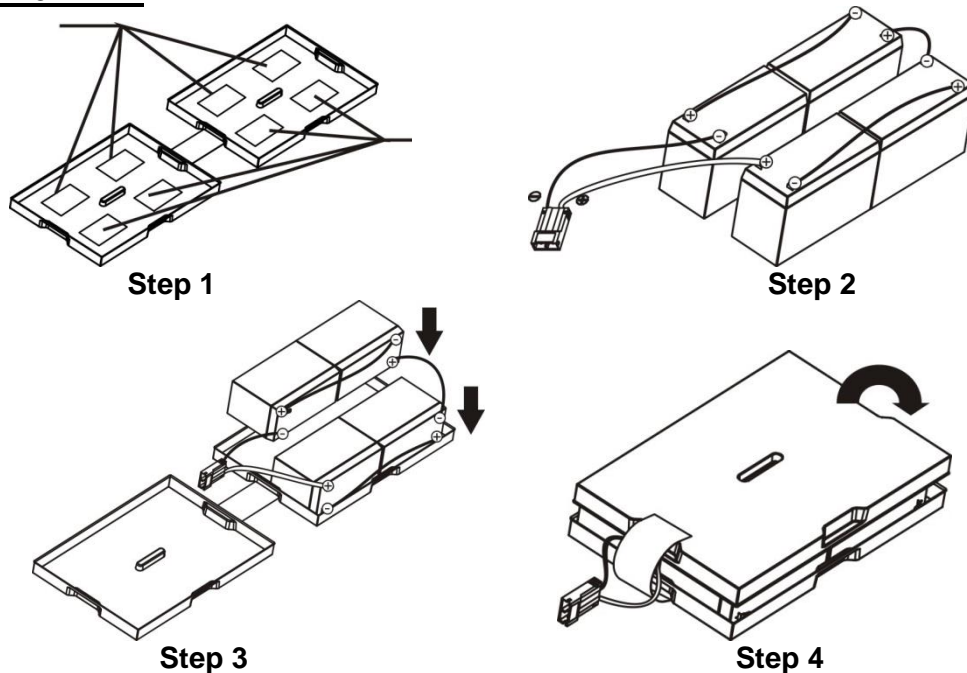

**Step 1:** Remove adhesive tapes.

**Step 2:** Connect all battery terminals by following below picture.

**Step 3:** Put assembled battery packs on one side of plastic shells.

**Step 4:** Cover the other side of plastic shell as shown below. Then, battery kit is fully assembled.

## 6-battery kit – 2.5-3kVA

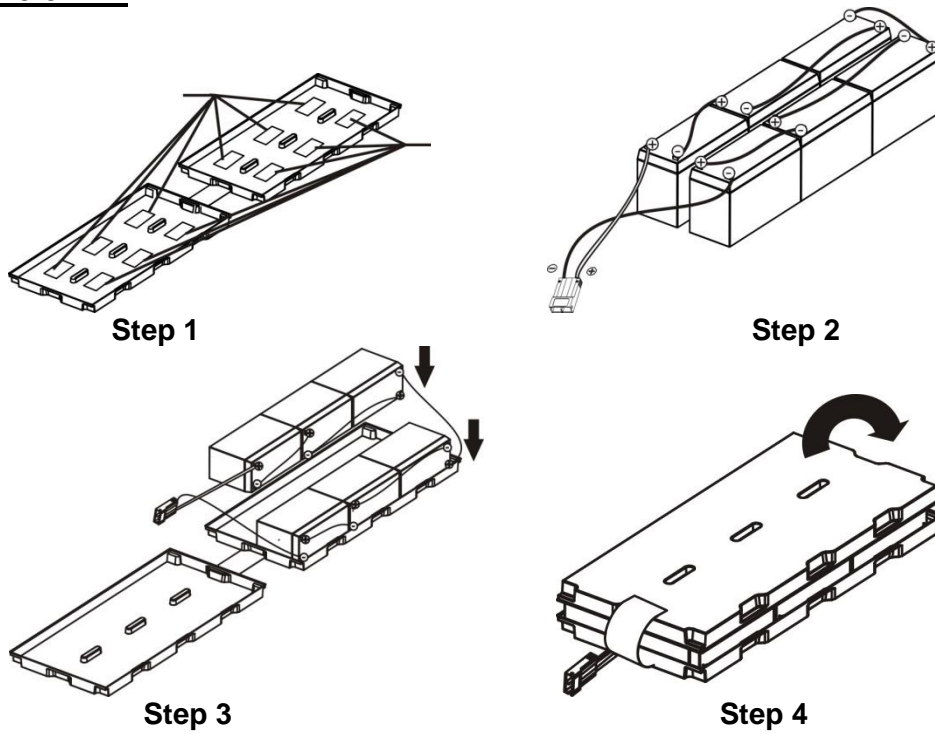

**Step 1:** Remove adhesive tapes.

**Step 2:** Connect all battery terminals by following below picture.

**Step 3:** Put assembled battery packs on one side of plastic shells.

**Step 4:** Cover the other side of plastic shell as shown below. Then, battery kit is fully assembled.

### 3. Operation

#### 3.1 Button operation

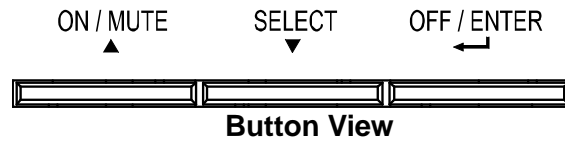





| Button                  | Function  |
|-------------------------|---|
| ON/Mute Button          | <ul style="list-style-type: none"> <li>➤ Turn on the UPS: Press and hold ON/Mute button for at least 2 seconds to turn on the UPS.</li> <li>➤ Mute the alarm: After the UPS is turned on in battery mode, press and hold this button for at least 3 seconds to disable or enable the alarm system. But it's not applied to the situations when warnings or errors occur.</li> <li>➤ Up key: Press this button to display previous selection in UPS setting mode.</li> <li>➤ Switch to UPS self-test mode: Press and hold ON/Mute button for 3 seconds to enter UPS self-testing while in AC mode</li> </ul> |
| OFF/Enter Button        | <ul style="list-style-type: none"> <li>➤ Turn off the UPS: Press and hold this button at least 2 seconds to turn off the UPS</li> <li>➤ Confirm selection key: Press this button to confirm selection in UPS setting mode.</li> </ul>   |
| Select Button           | <ul style="list-style-type: none"> <li>➤ Switch LCD message: Press this button to change the LCD message for input voltage, input frequency, battery voltage, output voltage and output frequency.</li> <li>➤ Setting mode: Press and hold this button for 3 seconds to enter UPS setting mode when UPS is off.</li> <li>➤ Down key: Press this button to display next selection in UPS setting mode.</li> </ul>  |
| ON/Mute + Select Button | <ul style="list-style-type: none"> <li>➤ Rack or Tower display switch: Press Select and OFF/Enter buttons simultaneously for 3 seconds. The display change from/to Rack to/from Tower.</li> </ul>   |

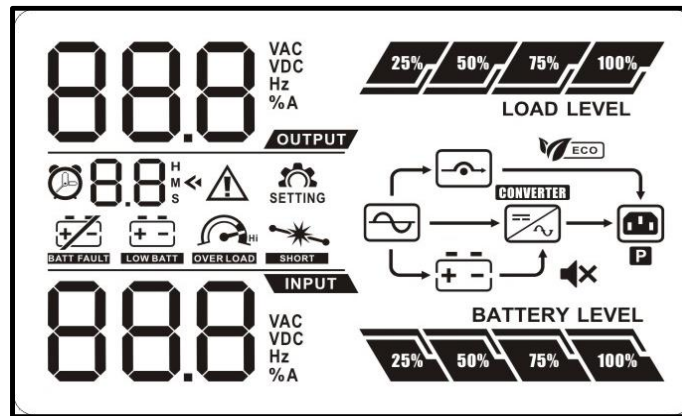

### 3.2 LCD Panel

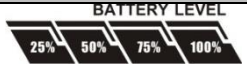

| Display                                    | Function   |
|--|--|
| <b>Backup time information</b>             |  |
|  | Indicates the estimated backup time.<br>H: hours, M: minute  |
| <b>Configuration and fault information</b> |  |
|  | Indicates the configuration items, and the configuration items are listed in details in section 3-5. |
|  | Indicates the warning and fault codes, and the codes are listed in details in section 3-7 and 3-8.   |
| <b>Output information</b>                  |  |
|  | Indicates the output voltage and output frequency.<br>V: voltage, Hz: frequency                      |
| <b>Load information</b>                    |  |
|  | Indicates the load level by 0-24%, 25-49%, 50-74%, and 75-100%.                                      |
|  | Indicates overload.  |
|  | Indicates the load or the UPS output is short circuited.   |
| <b>Programmable outlets information</b>    |  |
|  | Indicates that programmable management outlets are working.  |
| <b>Mode operation information</b>          |  |
|  | Indicates the UPS connects to the mains.   |
|  | Indicates the battery is working.  |
|  | Indicates the bypass circuit is working.   |
|  | Indicates the ECO mode is enabled.   |
|  | Indicates the inverter circuit is working.   |
|  | Indicates the output is working.   |
|  | Indicates that the UPS alarm is disabled.  |

| Battery information   |   |
|---|---|
|  | Indicates the Battery level by 0-24%, 25-49%, 50-74%, and 75-100%.  |
|  | Indicates the battery is fault.   |
|  | Indicates low battery level and low battery voltage.  |
| Input & Battery voltage information   |   |
|  | Indicates the input voltage, input frequency and battery voltage. Vac: Input voltage, Vdc: battery voltage, Hz: input frequency |

### 3.3 Audible Alarm

|              |                           |
|--------------|---------------------------|
| Battery Mode | Sounding every 10 seconds |
| Low Battery  | Sounding every 2 seconds  |
| Overload     | Sounding every second     |
| Fault        | Continuously sounding     |

### 3.4 LCD display wordings index

| Abbreviation | Display content | Meaning             |
|--------------|-----------------|---------------------|
| ENA          | ENR             | Enable              |
| DIS          | DIS             | Disable             |
| ESC          | ESC             | Escape              |
| ON           | ON              | ON                  |
| OK           | OK              | OK                  |
| EP           | EP              | EPO                 |
| AO           | AO              | Active open         |
| AC           | AC              | Active close        |
| TP           | TP              | Temperature         |
| CH           | CH              | Charger             |
| RAC          | RAC             | Rack display        |
| TOE          | TOE             | Tower display       |
| SF           | SF              | Site Fault          |
| EE           | EE              | EEPROM error        |
| BR           | BR              | Battery Replacement |

### 3.5 UPS Settings

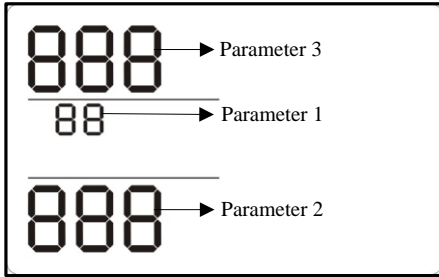

There are three parameters to set up the UPS.

Parameter 1: Program alternatives. Refer to below table.  
Parameter 2 and Parameter 3 are the setting options or values for each program.

#### 01: Output voltage setting

| Interface | Setting   |
|-----------|---|
|           | <p>For 110/115/120/127 VAC models:<br/>110: presents output voltage is 110Vac<br/>115: presents output voltage is 115Vac<br/>120: presents output voltage is 120Vac (Default)<br/>127: presents output voltage is 127Vac</p> <p>For 208/220/230/240 VAC models:<br/>208: presents output voltage is 208Vac<br/>220: presents output voltage is 220Vac<br/>230: presents output voltage is 230Vac (Default)<br/>240: presents output voltage is 240Vac</p> |

#### 02: Programmable outlets enable/disable

| Interface | Setting   |
|-----------|---|
|           | <p>ENA: Programmable outlets enable (Default)<br/>DIS: Programmable outlets disable</p> |

#### 03: Programmable outlets setting

| Interface | Setting   |
|-----------|---|
|           | <p>Setting the backup time limits in minutes from 0-999 for programmable outlets which connect to non-critical devices on battery mode.</p> |

04: Maximum charger current setting

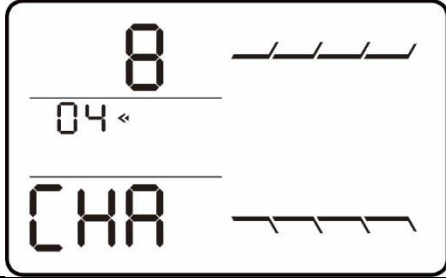
| Interface   | Setting   |
|---|---|
|  | <p>Set up the maximum charger current.<br/>                     1/2/4/6/8: setting the maximum charger current at 1/2/4/6/8 Ampere. (Default: 8A)<br/> <b>Note:</b> This setting is only effective for super charger.</p> |

06: Autonomy limitation setting

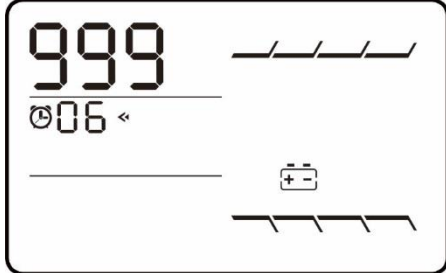
| Interface   | Setting  |
|---|--|
|  | <p>Parameter 2: Set up backup time on battery mode for general outlets.<br/>                     0-999: setting the backup time in minutes from 0-999 for general outlets on battery mode.<br/>                     DIS: Disable the autonomy limitation and the backup time will depend on battery capacity. (Default)<br/>                     Note: When setting as "0", the backup time will be only 10 seconds.</p> |

07: Battery total AH setting

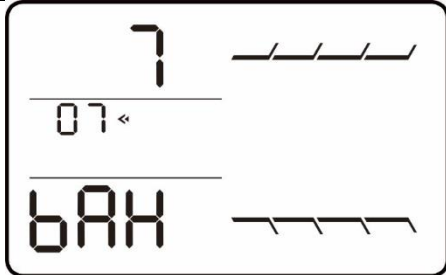

| Interface  | Setting   |
|--|---|
|  | <p>Parameter 2: Set up the battery total AH of the UPS.<br/>                     7-999: setting the battery total capacity from 7-999 in AH. Please set the correct battery total capacity if external battery bank is connected.</p> |

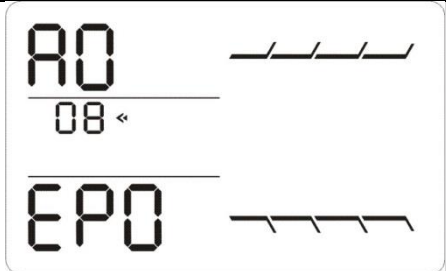
08: EPO logic setting

| Interface   | Setting   |
|---|---|
|  | <p>Set up the EPO function control logic.<br/> <b>AO:</b> Active Open (Default). When AO is selected as EPO logic, it will activate EPO function with Pin 1 and Pin 2 in open status.<br/> <b>AC:</b> Active Close. When AC is selected as EPO logic, it will activate EPO function with Pin 1 and Pin 2 in close status.</p> |

00: Exit setting

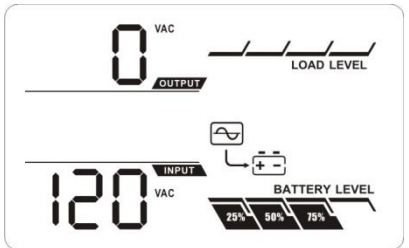
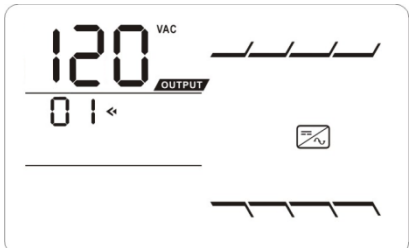

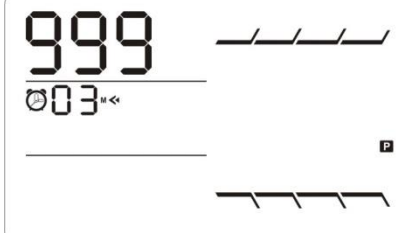
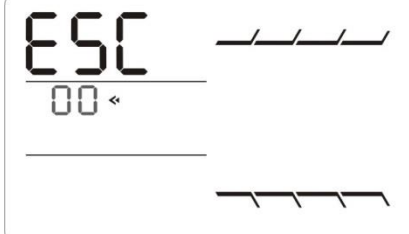

### 3.6 Steps for setting programmable outlet

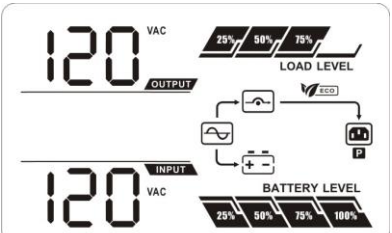
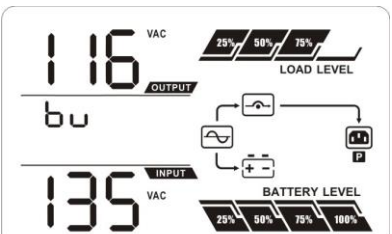
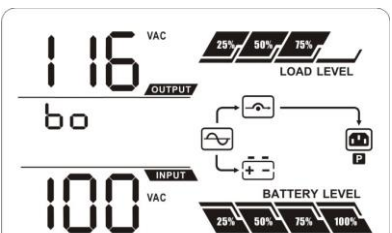
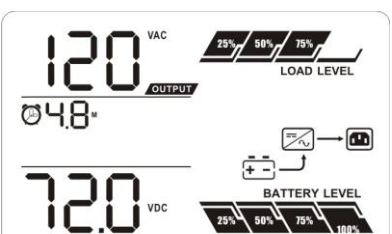
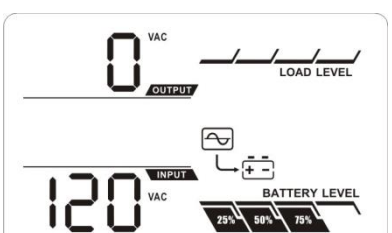
|  |   |
|--|---|
| <p><b>Step 1:</b><br/>Before entering setting mode, the UPS should be in Stand-by mode (off-charging) and make sure the battery is connected. The LCD display is shown as right.</p>   |    |
| <p><b>Step 2:</b><br/>Press and hold the "Selection" button for 3 seconds to enter Setting mode.</p>   |    |
| <p><b>Step 3:</b><br/>Press the "Up" button (ON/MUTE) to switch to "02" of program list. Then press "Enter" button to enter value setting of parameter 2. Press the "Up" button to change the value to "ENA" to enable the programmable outlet function. Then press "Enter" button again to confirm the setting.</p> |    |
| <p><b>Step 4:</b><br/>Press the "Up" button (ON/MUTE) again to switch to "03" of program list. Then press "Enter" button for setting programmable outlet time. Push "Up" button to change the value of backup time according your demand. Then press "Enter" to confirm the setting.</p>                             |   |
| <p><b>Step 5:</b><br/>Press "Up" button (ON/MUTE) to switch to "00" of program list. Then press "Enter" button to exit setting menu.</p>   |  |
| <p><b>Step 6:</b><br/>Disconnect AC input and wait until the LCD display is off. The new setting will be activated when turning on the UPS again.</p>  |   |























### 3.7 Operating Mode Description

| Operating mode                       | Description   | LCD display   |
|--------------------------------------|---|---|
| <b>ECO mode</b>                      | When the input voltage is within voltage regulated range, UPS will power the output directly from the mains. ECO is an abbreviation of Efficiency Corrective Optimizer. In this mode, when battery is fully charged, the fan will stop working for energy saving. |  <p>The LCD display for ECO mode shows an output voltage of 120 VAC and an input voltage of 120 VAC. The load level is indicated by a bar graph at 25%. The battery level is shown as a fully charged battery icon at 100%. A checkmark next to 'ECO' indicates this mode is active.</p> |
| <b>Buck mode when AC is normal.</b>  | When the input voltage is higher than the voltage regulation range but lower than high loss point, the buck AVR will be activated.  |  <p>The LCD display for Buck mode shows an output voltage of 116 VAC and an input voltage of 135 VAC. The load level is indicated by a bar graph at 25%. The battery level is shown as a fully charged battery icon at 100%.</p>   |
| <b>Boost mode when AC is normal.</b> | When the input voltage is lower than the voltage regulation range but higher than low loss point, the boost AVR will be activated.  |  <p>The LCD display for Boost mode shows an output voltage of 116 VAC and an input voltage of 100 VAC. The load level is indicated by a bar graph at 25%. The battery level is shown as a fully charged battery icon at 100%.</p>  |
| <b>Battery mode</b>                  | When the input voltage is beyond the acceptable range or power failure and alarm is sounding every 10 seconds, UPS will backup power from battery.  |  <p>The LCD display for Battery mode shows an output voltage of 120 VAC and a runtime of 4.8 hours. The load level is indicated by a bar graph at 25%. The battery level is shown as a fully charged battery icon at 100%.</p>   |
| <b>Standby mode</b>                  | UPS is powered off and no output supply power, but still can charge batteries.  |  <p>The LCD display for Standby mode shows an output voltage of 0 VAC and an input voltage of 120 VAC. The load level is indicated by a bar graph at 0%. The battery level is shown as a battery icon at 75%.</p>  |

### 3.8 Faults Reference Code











| Fault event              | Fault code | Icon | Fault event              | Fault code | Icon  |
|--------------------------|------------|------|--------------------------|------------|---|
| Bus start fail           | 01         | x    | Inverter output short    | 14         |  |
| Bus over                 | 02         | x    | Battery voltage too high | 27         |  |
| Bus under                | 03         | x    | Battery voltage too low  | 28         |  |
| Inverter soft start fail | 11         | x    | Over temperature         | 41         | x   |
| Inverter voltage high    | 12         | x    | Over load                | 43         |  |
| Inverter voltage Low     | 13         | x    | Charger failure          | 45         | x   |

### 3.9 Warning indicator

| Warning                  | Icon (flashing)   | Alarm  |
|--------------------------|---|--|
| Low Battery              |       | Sounding every 2 seconds   |
| Overload                 |       | Sounding every second  |
| Battery is not connected |       | Sounding every 2 seconds   |
| Over Charge              |       | Sounding every 2 seconds   |
| Site wiring fault        |       | Sounding every 2 seconds   |
| EPO enable               |       | Sounding every 2 seconds   |
| Over temperature         |       | Sounding every 2 seconds   |
| Charger failure          |       | Sounding every 2 seconds   |
| Battery fault            |       | Sounding every 2 seconds<br>(At this time, UPS is off to remind users of something wrong with battery) |
| EEPROM error             |   | Sounding every 2 seconds   |
| Battery replacement      |   | Sounding every 2 seconds   |

## 4. Troubleshooting

If the UPS system does not operate correctly, use the table below to check problem.

| Symptom   | Possible cause  | Remedy   |
|---|---|--|
| No indication and alarm even though the mains is normal.  | The AC input power is not connected well.                                       | Check if input power cord firmly connected to the mains.   |
|   | The AC input is connected to the UPS output.                                    | Plug AC input power cord to AC input correctly.  |
| The icon  and the warning code <b>EP</b> flashing on LCD display and alarm is sounding every 2 seconds.  | EPO function is activated.  | Set the circuit in close position to disable EPO function.   |
| The icon  and  flashing on LCD display and alarm is sounding every 2 seconds.               | Line and neutral conductors of UPS input are reversed.                          | Rotate mains power socket by 180° and then connect to UPS system.  |
| The icon  and  flashing on LCD display and alarm is sounding every 2 seconds.               | The external or internal battery is incorrectly connected.                      | Check if all batteries are connected well.   |
| Fault code is shown as 27 and the icon  is lighting on LCD display and alarm is continuously sounding.   | Battery voltage is too high or the charger is fault.                            | Contact your dealer.   |
| Fault code is shown as 28 and the icon  is lighting on LCD display and alarm is continuously sounding.  | Battery voltage is too low or the charger is fault.                             | Contact your dealer.   |
| The icon  and the icon  are flashing on LCD display and alarm is sounding every second. | UPS is overload   | Remove excess loads from UPS output.   |
| Fault code is shown as 43 and The icon  is lighting on LCD display and alarm is continuously sounding.   | The UPS shut down automatically because of overload at the UPS output.          | Remove excess loads from UPS output and restart it.  |
| Fault code is shown as 14 and alarm is continuously sounding.   | The UPS shut down automatically because short circuit occurs on the UPS output. | Check output wiring and if connected devices are in short circuit status.  |
| Fault code is shown as 01, 02, 03, 11, 12, 13 and 41 on LCD display and alarm is continuously sounding.   | A UPS internal fault has occurred.  | Contact your dealer  |
| Battery backup time is shorter than nominal value   | Batteries are not fully charged   | Charge the batteries for at least 5 hours and then check capacity. If the problem still persists, consult your dealer. |
|   | Batteries defect  | Contact your dealer to replace the battery.  |
| Fault code is shown as 45 on LCD display. At the same time, alarm is continuously sounding.   | The charger does not have output and battery voltage is less than 10V/PC.       | Contact your dealer.   |



## 5. Storage and Maintenance

### 5.1 Operation

The UPS system contains no user-serviceable parts. If the battery service life (3-5 years at 25°C ambient temperature) has been exceeded, the batteries must be replaced. In this case, please contact the manufacturer for replacement battery packs.



Be sure to deliver the spent battery to a recycling facility.

### 5.2 Storage

Before storing, charge the UPS for 5 hours. Store the UPS covered and upright in a cool, dry location. During storage, recharge the battery in accordance with the following table:

| <b>Storage Temperature</b>   | <b>Recharge Frequency</b> | <b>Charging Duration</b> |
|------------------------------|---------------------------|--------------------------|
| -25°C - 40°C (-13°F - 104°F) | Every 3 months            | 1-2 hours                |
| 40°C - 45°C (104°F - 113°F)  | Every 2 months            | 1-2 hours                |

## 6. UPS Specifications

### 6.1 120V Models

| MODEL                           | 800   | 1.1K          | 1.5K                 | 2K             | 3K                   |
|---------------------------------|---|---------------|----------------------|----------------|----------------------|
| <b>CAPACITY</b>                 | 800VA / 720W  | 1100VA / 990W | 1500VA / 1350W       | 2000VA / 1800W | 3000VA / 2700W*      |
| <b>INPUT</b>                    |   |               |                      |                |                      |
| Acceptable Voltage Range        | 81-145 VAC  |               |                      |                |                      |
| Frequency Range                 | 60/50 Hz (auto sensing)   |               |                      |                |                      |
| <b>OUTPUT</b>                   |   |               |                      |                |                      |
| Voltage Regulation (Batt. Mode) | 110/115/120/127 VAC $\pm$ 1.5% (before battery alarm)                               |               |                      |                |                      |
| Frequency Range (Batt. Mode)    | 50 Hz or 60 Hz $\pm$ 1 Hz   |               |                      |                |                      |
| Current Crest Ratio             | 3:1   |               |                      |                |                      |
| Harmonic Distortion             | 2% max @ 100% linear load, 5% max @ 100% non-linear load (before low battery alarm) |               |                      |                |                      |
| Transfer Time                   | Typical 2-6 ms, 10ms max.   |               |                      |                |                      |
| Waveform (Batt. Mode)           | Pure Sine Wave  |               |                      |                |                      |
| <b>EFFICIENCY</b>               |   |               |                      |                |                      |
| AC Mode                         | 95%   |               |                      |                |                      |
| Buck & Boost Mode               | 93%   |               |                      |                |                      |
| Battery Mode                    | 88%   |               | 90%                  |                | 90%                  |
| <b>BATTERY</b>                  |   |               |                      |                |                      |
| Battery Type & Number           | 12 V/7 Ahx2   | 12 V/9 Ahx2   | 12 V/7 Ahx4          | 12 V/9 Ahx4    | 12 V/9 Ahx6          |
| Charging Voltage                | 27.4 VDC $\pm$ 1%   |               | 54.8 VDC $\pm$ 1%    |                | 82.1 VDC $\pm$ 1%    |
| Recharge Time                   | 4 hours recover to 90% capacity   |               |                      |                |                      |
| Charging Current                | 1.5A  |               |                      |                |                      |
| <b>PROTECTION</b>               |   |               |                      |                |                      |
| Full Protection                 | Overload, short, discharge, and overcharge protection                               |               |                      |                |                      |
| <b>ALARM</b>                    |   |               |                      |                |                      |
| Battery Mode                    | Sounding every 10 seconds   |               |                      |                |                      |
| Low Battery                     | Sounding every 2 seconds  |               |                      |                |                      |
| Overload                        | Sounding every second   |               |                      |                |                      |
| Battery Replacement Alarm       | Sounding every 2 seconds  |               |                      |                |                      |
| Fault                           | Continuously sounding   |               |                      |                |                      |
| <b>PHYSICAL</b>                 |   |               |                      |                |                      |
| Dimension, DXWXH (in)           | 16.14 x 17.25 x 3.46  |               | 20.08 x 17.25 x 3.46 |                | 24.80 x 17.25 x 3.46 |
| Dimension, DXWXH (mm)           | 410 x 438 x 88  |               | 510 x 438 x 88       |                | 630 x 438 x 88       |
| Net Weight (lb)                 | 28.4  | 29.5          | 43.0                 | 47.4           | 64.6                 |
| Net Weight (kg)                 | 12.9  | 13.4          | 19.5                 | 21.5           | 29.3                 |
| <b>ENVIRONMENT</b>              |   |               |                      |                |                      |
| Operating Humidity              | 0-90 % RH @ 0- 40°C (non-condensing)  |               |                      |                |                      |
| Noise Level                     | Less than 45dB  |               |                      |                |                      |
| <b>MANAGEMENT</b>               |   |               |                      |                |                      |
| Smart RS-232/USB                | Supports Windows® 2000/2003/XP/Vista/2008, 7/8, Linux, Unix, and MAC                |               |                      |                |                      |
| Optional SNMP                   | Power management from SNMP manager and web browser                                  |               |                      |                |                      |

\*For 3kVA unit

| <u>Output Voltage setting</u> | <u>Power Rating</u> |
|-------------------------------|---------------------|
| 127Vac                        | 3000VA/2700W        |
| 120Vac                        | 2880VA/2592W        |
| 115Vac                        | 2760VA/2484W        |
| 110Vac                        | 2640VA/2376W        |

## 6.2 230V Models

| MODEL                           | 800   | 1.1K             | 1.5K                 | 2K                | 3K                   |
|---------------------------------|---|------------------|----------------------|-------------------|----------------------|
| <b>CAPACITY*</b>                | 800VA /<br>720W   | 1100VA /<br>990W | 1500VA /<br>1350W    | 2000VA /<br>1800W | 3000VA /<br>2700W    |
| <b>INPUT</b>                    |   |                  |                      |                   |                      |
| Acceptable Voltage Range        | 162-290 VAC   |                  |                      |                   |                      |
| Frequency Range                 | 60/50 Hz (auto sensing)   |                  |                      |                   |                      |
| <b>OUTPUT</b>                   |   |                  |                      |                   |                      |
| Voltage Regulation (Batt. Mode) | 208/220/230/240 VAC $\pm$ 1.5% (before battery alarm)                               |                  |                      |                   |                      |
| Frequency Range (Batt. Mode)    | 50 Hz or 60 Hz $\pm$ 1 Hz   |                  |                      |                   |                      |
| Current Crest Ratio             | 3:1   |                  |                      |                   |                      |
| Harmonic Distortion             | 2% max @ 100% linear load, 5% max @ 100% non-linear load (before low battery alarm) |                  |                      |                   |                      |
| Transfer Time                   | Typical 2-6 ms, 10ms max.   |                  |                      |                   |                      |
| Waveform (Batt. Mode)           | Pure Sine Wave  |                  |                      |                   |                      |
| <b>EFFICIENCY</b>               |   |                  |                      |                   |                      |
| AC Mode                         | 97%   |                  |                      |                   |                      |
| Buck & Boost Mode               | 95%   |                  |                      |                   |                      |
| Battery Mode                    | 89%   |                  | 91%                  |                   | 92%                  |
| <b>BATTERY</b>                  |   |                  |                      |                   |                      |
| Battery Type & Number           | 12 V/7<br>Ahx2  | 12 V/9<br>Ahx2   | 12 V/7<br>Ahx4       | 12 V/9<br>Ahx4    | 12 V/9 Ahx6          |
| Charging Voltage                | 27.4 VDC $\pm$ 1%   |                  | 54.8 VDC $\pm$ 1%    |                   | 82.1 VDC $\pm$ 1%    |
| Recharge Time                   | 4 hours recover to 90% capacity   |                  |                      |                   |                      |
| Charging Current                | 1.5A  |                  |                      |                   |                      |
| <b>PROTECTION</b>               |   |                  |                      |                   |                      |
| Full Protection                 | Overload, short, discharge, and overcharge protection                               |                  |                      |                   |                      |
| <b>ALARM</b>                    |   |                  |                      |                   |                      |
| Battery Mode                    | Sounding every 10 seconds   |                  |                      |                   |                      |
| Low Battery                     | Sounding every 2 seconds  |                  |                      |                   |                      |
| Overload                        | Sounding every second   |                  |                      |                   |                      |
| Battery Replacement Alarm       | Sounding every 2 seconds  |                  |                      |                   |                      |
| Fault                           | Continuously sounding   |                  |                      |                   |                      |
| <b>PHYSICAL</b>                 |   |                  |                      |                   |                      |
| Dimension, DXWXH (in)           | 16.14 x 17.25 x 3.46  |                  | 20.08 x 17.25 x 3.46 |                   | 24.80 x 17.25 x 3.46 |
| Dimension, DXWXH (mm)           | 410 x 438 x 88  |                  | 510 x 438 x 88       |                   | 630 x 438 x 88       |
| Net Weight (lb)                 | 28.4  | 29.5             | 43.0                 | 47.4              | 64.6                 |
| Net Weight (kg)                 | 12.9  | 13.4             | 19.5                 | 21.5              | 29.3                 |
| <b>ENVIRONMENT</b>              |   |                  |                      |                   |                      |
| Operating Humidity              | 0-90 % RH @ 0- 40°C (non-condensing)  |                  |                      |                   |                      |
| Noise Level                     | Less than 45dB  |                  |                      |                   |                      |
| <b>MANAGEMENT</b>               |   |                  |                      |                   |                      |
| Smart RS-232/USB                | Supports Windows® 2000/2003/XP/Vista/2008, 7/8, Linux, Unix, and MAC                |                  |                      |                   |                      |
| Optional SNMP                   | Power management from SNMP manager and web browser                                  |                  |                      |                   |                      |

\* Derate capacity to 80% of capacity when the output voltage is adjusted to 208VAC.

## Battery Pack Specification

| Model                 | SCV-BAT-1K           | SCV-BAT-2K           | SCV-BAT-3K           |
|-----------------------|----------------------|----------------------|----------------------|
| Used with UPS Models  | 0.8~1.1kVA           | 1.5~2kVA             | 3kVA                 |
| Battery Type          | 12V 9Ah              | 12V 9Ah              | 12V 9Ah              |
| Battery Numbers       | 4                    | 8                    | 12                   |
| Dimension, DXWXH (in) | 15.78 x 17.24 x 3.39 | 19.72 x 17.24 x 3.39 | 24.44 x 17.24 x 3.39 |
| Dimension, DXWXH (mm) | 401 x 438 x 86       | 501 x 438 x 86       | 621 x 438 x 86       |
| Net Weight (lb)       | 38                   | 64                   | 91                   |
| Net Weight (kg)       | 17.2                 | 29.0                 | 41.3                 |

**NOTE:** Battery pack should be used with corresponded UPS.

When more than 1 set of external battery pack is used (or battery capacity is more than 18AH), please reduce the connected load to 80% of UPS capacity.

**Notes:**