

RWS 100B-600B Series

Instruction Manual

BEFORE USING THE POWER SUPPLY UNIT

Be sure to read this instruction manual thoroughly before using this product. Pay attention to all cautions and warnings before using this product. Incorrect usage could lead to an electrical shock, damage to the unit or a fire hazard.

DANGER

Never use this product in locations where flammable gas or ignitable substances are present. There are risks of igniting these substances and exploding by an arcing.

WARNING

- Do not touch this product or its internal components while circuit in operation, or shortly after shutdown. There may be high voltage or high temperature present and you may receive an electric shock or burn.
- While this product is operating, keep your hands and face away from it as you may be injured by an unexpected situation.
- Do not make unauthorized changes to this product, otherwise you may receive an electric shock and void your warranty.
- Do not drop or insert anything into this product. It might cause a failure, fire and electric shock.
- Do not use this product under unusual condition such as emission of smoke or abnormal smell and sound etc. It might lead to fire and electric shock. In such cases, please contact us. Do not attempt repair by yourself, as it is dangerous for the user.
- Do not operate these products in the presence of condensation. It might lead fire and electric shock.

CAUTION

- This power supply is designed and manufactured for use within an end product such that it is accessible to SERVICE ENGINEERS only.
- Confirm connections to input/output terminals are correct as indicated in the instruction manual before switching on.
- Input voltage, Output current, Output power, ambient temperature and ambient humidity should be kept within specifications, otherwise the product will be damaged.
- Do not operate and store this product in an environment where condensation might occur. In such case, waterproof treatment is necessary.
- Do not use this product in environment with a strong electromagnetic field, corrosive gas or conductive substances.
- For applications, which require very high reliability (Nuclear related equipment, medical equipment, traffic control equipment, etc.), it is necessary to provide a fail-safe mechanism in the end equipment.
- Do not inject abnormal voltages into the output or signal of this product. The injection of reverse voltage or over voltage exceeding nominal output voltage into the output or signal terminals might cause damage to internal components.
- Never operate the product under over current or short-circuit conditions, or outside its specified Input Voltage Range. Insulation failure, smoking, burning or other damage may occur.
- This product contains a printed circuit board utilizing surface mounted devices. PCB stress such as bending, twisting etc. could cause damage. Therefore, please handle with care.
- This power supply has possibility that hazardous voltage may occur in output terminal depending on failure mode. The output of these products must be protected in the end use equipment to maintain SELV.
- The output of RWS300B and RWS600B is considered to be a hazardous energy level (The voltage is 2V or more and the power is 240VA or more). It must not be made accessible to users. Protection must be provided for Service Engineers against indirect contact with the output terminals and/or to prevent tools being dropped across them. While working on this product, the AC input power must be switched off and the input and output voltage should be zero.
- RWS300B, RWS600B have a built-in fan for air-cooling. Do not block the air intake and exhaust as this might lead to fire.
- The information in this document is subject to change without prior notice. Please refer to the latest version of the data sheet, etc., for the most up-to date specifications of the product.
- No part of this document may be copied or reproduced in any form without prior written consent of TDK-Lambda.

Note : CE MARKING

CE Marking when applied to a product covered by this handbook indicates compliance with the low voltage directive (2006/95/EC) in that it complies with EN60950-1.

1. Model name identification method

RWS 100B – 5 / □

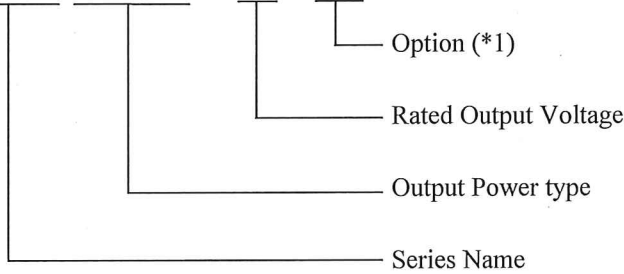

(*1) Blank : Standard

/R : With remote ON/OFF control model.
 (Option of RWS600B)

/FO : With remote sensing
 Low output voltage (LV) signal
 Parallel Operation
 (Option of RWS600B)

/DIN : DIN rail mountable
 (Option of RWS100B, RWS150B)

2. Terminal Explanation

RWS100B, RWS150B, RWS300B

- ① N : Input terminal Neutral line
- ② L : Input terminal Live line (Fuse in line)
- ③ \perp : Earth terminal
- ④ -V : - Output terminal
(30A max. / terminal)
- ⑤ +V : + Output terminal
(30A max. / terminal)
- ⑥ Output voltage adjustment trimmer
- ⑦ Output monitoring indicator (Green LED)
(RWS100B)
- ⑧ Output monitoring indicator (Green LED)
(RWS150B)
- ⑨ Output monitoring indicator (Green LED)
(RWS300B)

*All screws size is M3.5

RWS100B, RWS150B

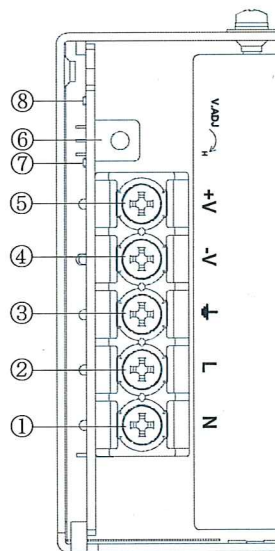

RWS300B

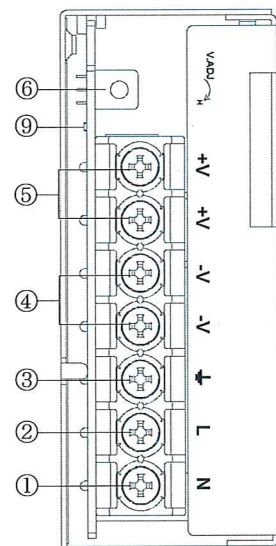

RWS600B

- ① N : Input terminal Neutral line (M3.5 screw)
- ② L : Input terminal Live line (Fuse in line) (M3.5 screw)
- ③ ⊥: Earth terminal
- ④ -V : - Output terminal (50A max. / terminal, M5 screw)
- ⑤ +V : + Output terminal (50A max. / terminal, M5 screw)
- ⑥ Output voltage adjustment trimmer
- ⑦ Output monitoring indicator (Green LED)

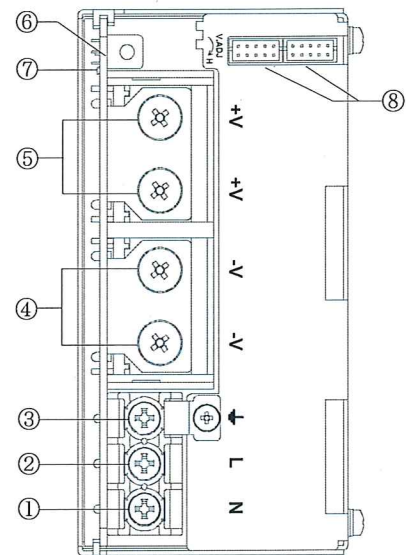

RWS600B/FO

- ⑧CN81, CN82 : Remote sensing, LV signal, Parallel operation setup

CN81,CN82 Connector pin Configuration and Function

CN81 and CN82 are same pin configuration and function.

They are connected to each other in this power supply unit.

When the pin of CN81 side is shorted, the same function pins of CN82 side are also shorted.

Please note that the function cannot be separately set with CN81 and CN82.

	No.	Configuration	Function
	1	+Vm	Output monitor terminal (+V). (+Vm terminal can not supply load current.)
	2	+S	Remote sensing terminal for +output. (For remote sensing function, which compensates for line drop between power supply terminals and load terminals. Connect to +Vm terminal when remote sensing function unnecessary.)
	3	NC	No connect
	4	NC	No connect
	5	+LV	Low output voltage detection signal (LV signal) terminal. (Open collector output. As the output voltage drops, "LV" signal will be "High".)
	6	-LV	GND for LV signal.
	7	+P	Parallel operation setup terminal. (Connect to -P terminal for parallel operation.)
	8	-P	Parallel operation setup terminal. (Connect to +P terminal for parallel operation.)
	9	-Vm	GND for Output monitor terminal. (-Vm terminal can not supply load current.)
	10	-S	Remote sensing terminal for -output side. (For remote sensing function, which compensates for line drop between power supply terminals and load terminals. Connect to -Vm terminal when remote sensing function unnecessary.)

* CN81, CN82 Connector (JST)

Connector	Housing	Terminal Pin
S10B-PHDSS	PHDR-10VS	SPHD-002T-P0.5 (A WG28~24) or SPHD-001T-P0.5 (A WG26~22)

Hand Crimping Tool : YRS-620 (JST)

Please use maker recommended crimping tool.

RWS600B/R

⑧CN81 : Remote ON/OFF control

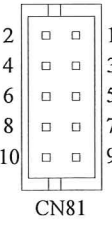
	No.	Configuration	Function
	1	NC	No connect
	2	NC	No connect
	3	+R	Remote ON/OFF control terminal.
	4	-R	GND for Remote ON/OFF control terminal.
	5	NC	No connect
	6	NC	No connect
	7	NC	No connect
	8	NC	No connect
	9	NC	No connect
	10	NC	No connect

* CN81, CN82 Connector (JST)

Connector	Housing	Terminal Pin
S10B-PHDSS	PHDR-10VS	SPHD-002T-P0.5 (AWG28~24) or SPHD-001T-P0.5 (AWG26~22)

Hand Crimping Tool : YRS-620 (JST)

Please use maker recommended crimping tool.

Matching housing and terminal pin are not included in the product.

3. Connecting method

Pay attention to the input wiring. If it is connected to wrong terminal, the power supply will be damaged.

- Input must be off when making connections.
- Connect \perp terminal to earth (frame ground of the equipment etc.) by thick wire for safety and improvement of noise sensitivity.

RWS100B, RWS150B

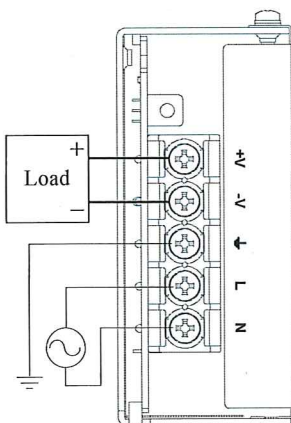

RWS300B

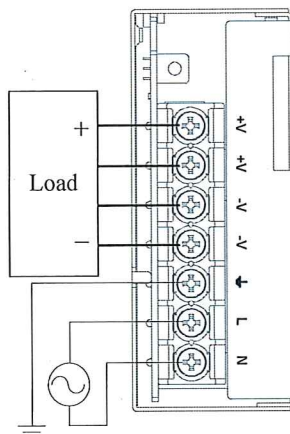

RWS600B

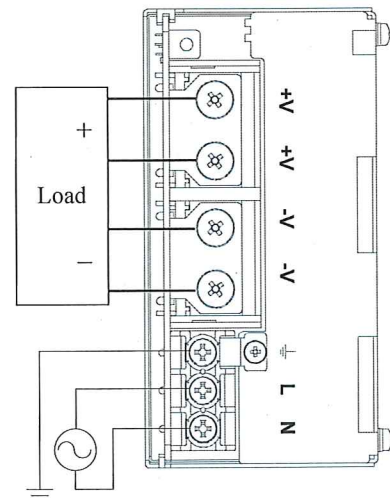

Recommended torque : RWS100B~RWS600B
RWS600B

M3.5 screw
M5 screw

1.0N·m(10.2kgf·cm)~1.6N·m(16.3kgf·cm)
2.2N·m(22.4kgf·cm)~2.8N·m(28.6kgf·cm)

RWS600B/FO

• **Basic connection (Local sensing)**

Connect "+S" terminal (Pin No.2) to "+Vm" terminal (Pin No.1), and "-S" terminal (Pin No.10) to "-Vm" terminal (Pin No.9) with the attached short pieces.

(Short pieces are mounted at time of shipment.)

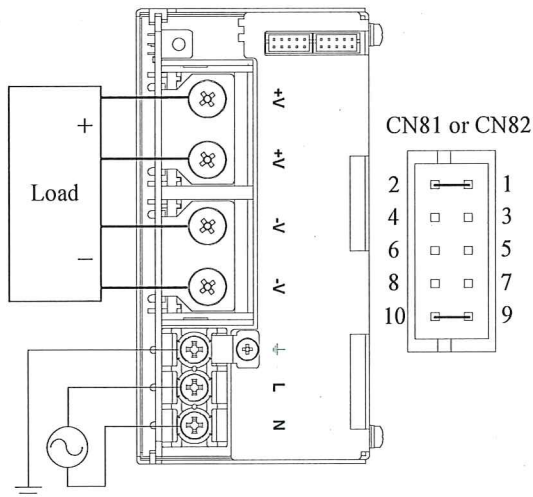

• **Remote sensing connection**

- 1) Connect "+S" terminal (Pin No.2) to "+" output terminal of load with wires.
- 2) Connect "-S" terminal (Pin No.10) to "-" output terminal of load with wires.

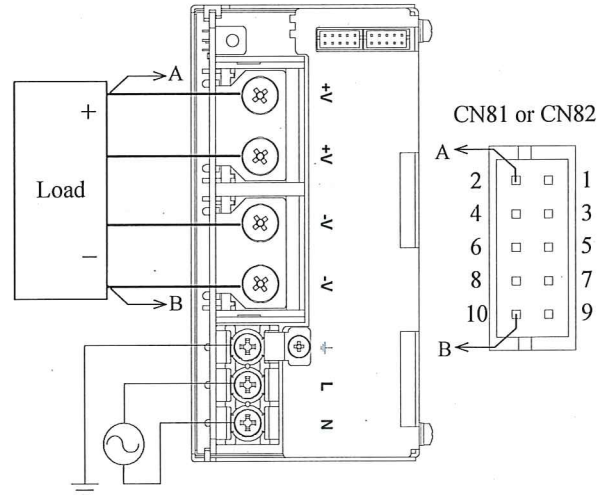

*If remote sensing terminals are opened, the output will rise and OVP may be triggered.

• **LV signal output**

LV signal is open collector output.
 Use as shown below.

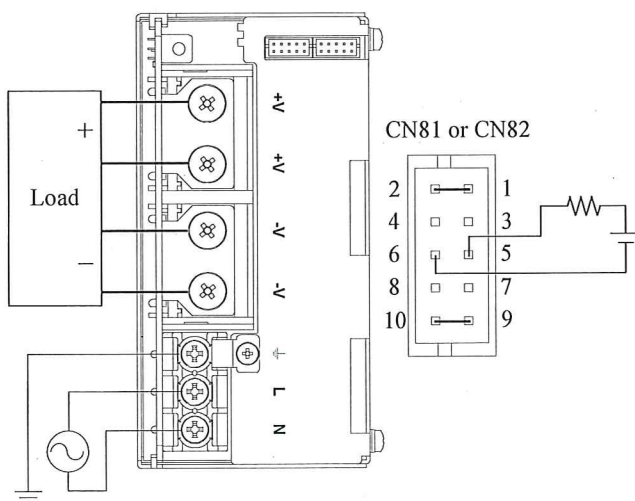

• Parallel operation

Connect “+P” terminal (Pin No.7) ~ “-P” terminal (Pin No.8) for parallel operation.

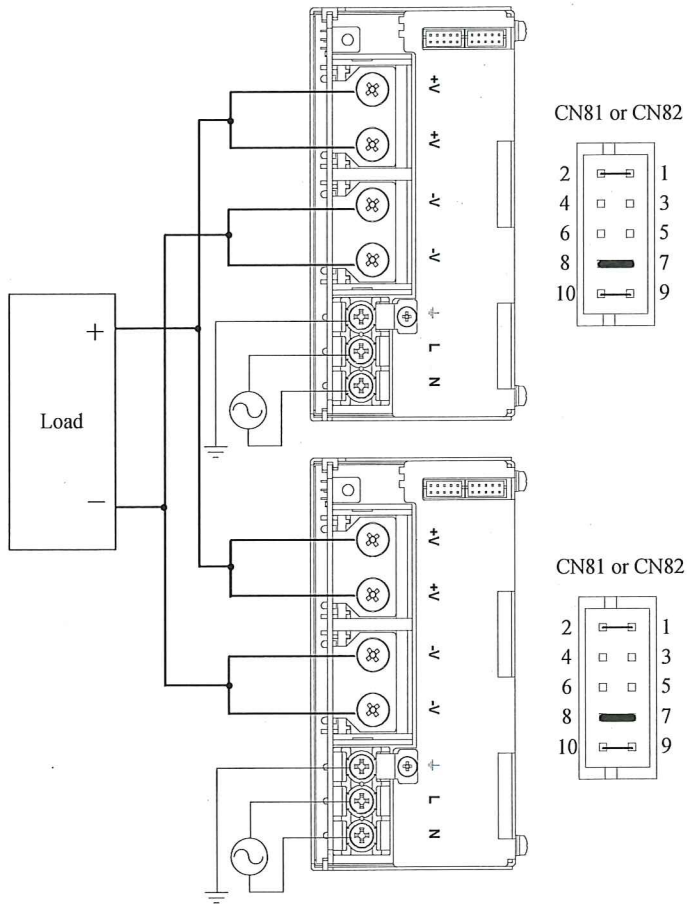

RWS600B/R

• Remote ON/OFF control connection

Connect external voltage between “+R” terminal (Pin No.3) and “-R” terminal (Pin No.4) for remote ON/OFF control.

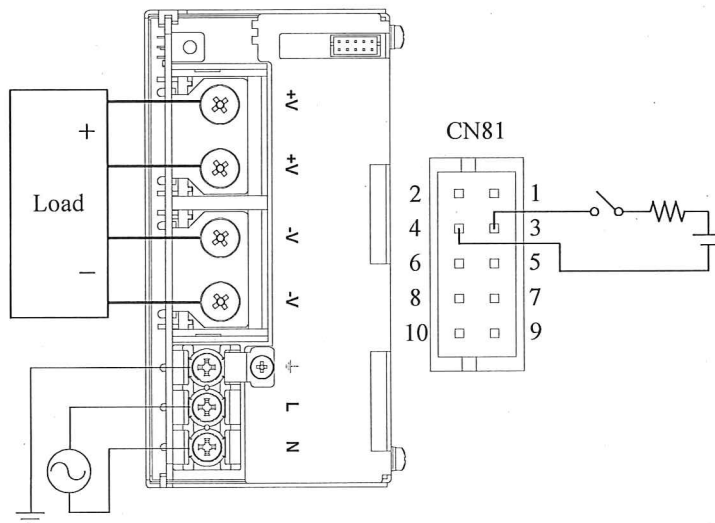

4. Explanation of Functions and Precautions

4-1. Input Voltage Range

Input voltage range is single phase 85-265VAC (47-63Hz) or 120-370VDC(RWS600B : 120-330VDC). Input voltage, which is out of specification, might lead unit damage. For cases where conformance to various safeties required, described as 100-240VAC (50-60Hz).

Output derating is required for AC input voltage less than 110VAC or DC input voltage.

Note : RWS-B series is able to withstand input of 300VAC for 5 seconds (No damage). Please note that to satisfy the electrical characteristics, the input voltage must be within 85-265VAC.

4-2. Output Voltage Range

Output voltage is set at the rated value. Output voltage within the range specified can be adjusted by V.ADJ trimmer. Output voltage range is within +15% / -10%(48V : ±10%) of nominal output voltage.

Turning the trimmer clockwise, the output voltage will be increased. Take note when the output voltage is increased excessively, over voltage protection (OVP) function may trigger and voltage will be shut down. Furthermore, when increasing the output voltage, reduce the output current as not to exceed the maximum output power.

When the trimmer turns quickly at no load condition, the output voltage might become unstable. To maintain the output voltage stable, flow the output current, or remove the input of power supply until the output be shut down, and then re-input. Please turn the trimmer slowly during the output voltage adjustment.

4-3. Inrush Current

Power thermistor or Thyristor is used for limiting the inrush current.

RWS100B, RWS150B, RWS300B

Power thermistor method is used for these models. Higher current will flow at higher ambient temperature or input turn on condition. Please select input switch or external fuse carefully. The inrush current value specified in the specification is under cold start condition (at 25°C).

RWS600B

Thyristor method is used for RWS600B. Higher current may flow when input turn on interval is short.

First inrush current and second inrush current flow.

The inrush current value in the specification is first inrush current. Please select input switch and external fuse carefully.

4-4. Over Voltage Protection (OVP)

The OVP function is inverter shut down method and manual reset type. OVP function operates within 120-140% (48V : 115-135%) of nominal output voltage.

When OVP triggers, the output will be shut down. To reset OVP, remove the input of power supply for a few minutes, and then re-input. In addition, the setting value of OVP is fixed and not adjustable. Never apply higher voltage externally to the output terminal to avoid unit failure. In case of inductive load, put protective diode in series to the output power line.

4-5. Over Current Protection (OCP)

5-15V : Constant current limit and hiccup with automatic recovery.

24V-48V : Constant current limit with automatic recovery.

OCP function operates when the output current exceeds 105% of maximum DC output current of specification.

The outputs will be automatically recovered when the overload condition is removed. Never operate the unit under over current or shorted conditions, which may lead unit damage. OCP setting is fixed and cannot be adjusted externally.

Never adjust the trimmer absolutely as shown below. OCP function will not operate normally if the trimmer is turned.

RWS150B

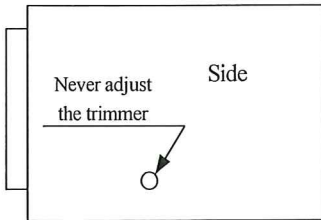

RWS300B

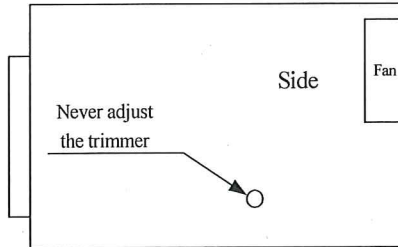

4-6. Output Ripple & Noise

The standard specification for maximum ripple value is measured according to measurement circuit specified by JEITA-RC9131B. When load lines are longer, ripple will become larger. In this case, electrolytic capacitor, film capacitor, etc. might be necessary to use across the load terminal.

The output ripple cannot be measured accurately if the probe ground lead of oscilloscope is too long.

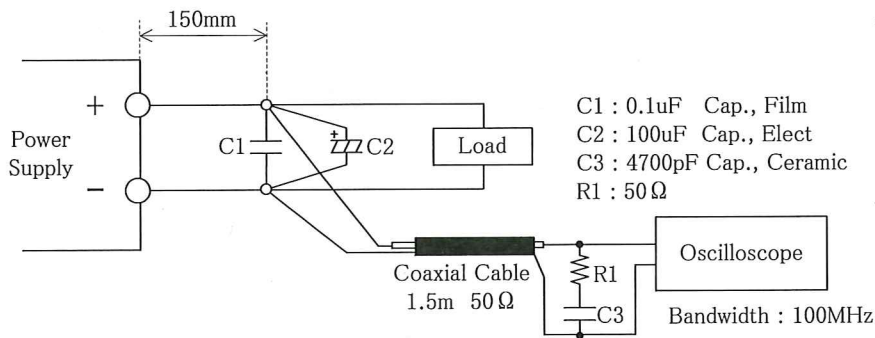

4-7. Series Operation

For series operation, either method (A) or (B) is possible.

Method (A)

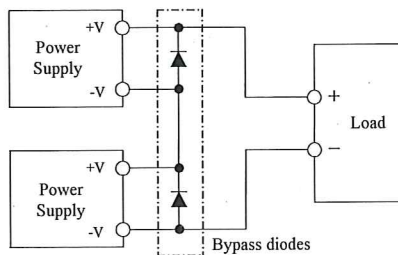

Method (B)

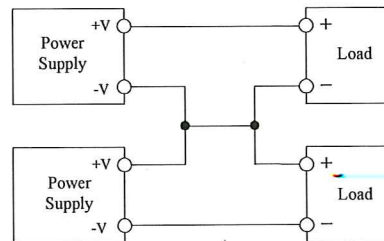

Note : In case of method (A), never use condition that one of the unit is not operated. The unit might cause damage.
 When one of the unit is not operated, please connect bypass diodes.
 Please select a bypass diode with maximum forward current rating more than output load current.
 And maximum reverse voltage must more than each power supply output voltage.

4-8. Parallel Operation

(A) Operation to increase the Output Current is not possible.

(B) Operation as a Backup System is acceptable.

1. Adjust the output voltage higher by the value of forward voltage drop (V_F) of the diode.
2. Adjust each power supply output to same voltage.
3. Output voltage and output power should be used within specifications.
4. Use blocking diode to prevent reverse current. Diode current rating must be more than output load current.

(A)

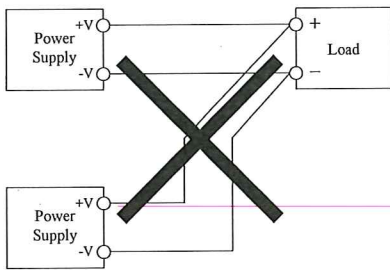

(B)

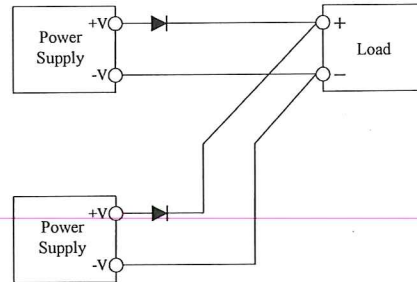

RWS600B/FO

(A) Operation to increase the Output Current is possible.

By connecting +P terminal (Pin No.7) and -P terminal (Pin No.8), OCP is set up to less than 100% and parallel operation is possible.

1. Adjust each power supply output to same voltage
2. Connection wires between power supply and load should be same type and same length.
3. Each power supply output power must be less than 85% of rating.
4. Parallel connection is acceptable up to 5 unit maximum.

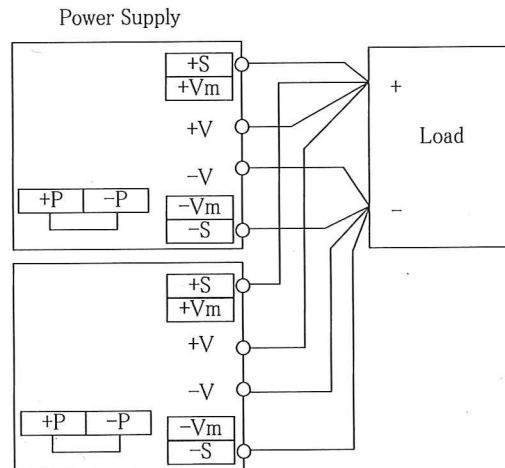
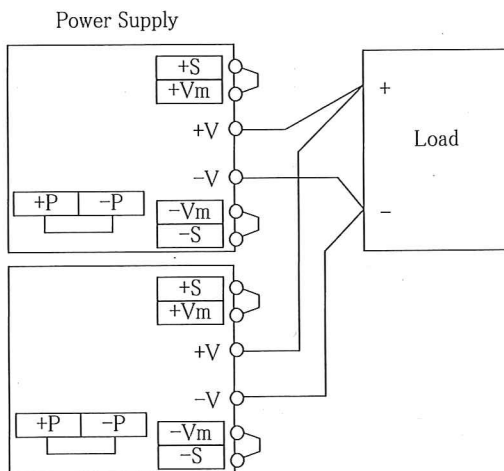

4-9. Isolation Test

Isolation resistance between Output - \perp terminal is more than 100M Ω at 500VDC. For safety operation, voltage setting of DC isolation tester must be done before the test. Ensure that the unit is fully discharged after the test.

Output - \perp terminal : 500VDC More than 100M Ω

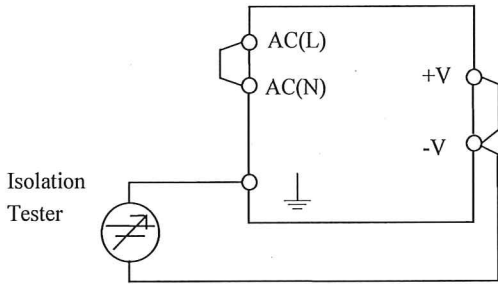

RWS600B/FO

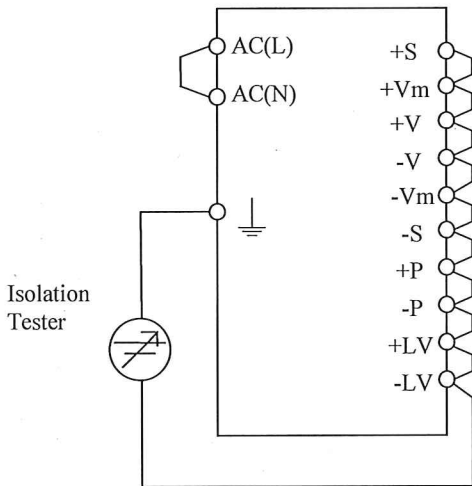

RWS600B/R

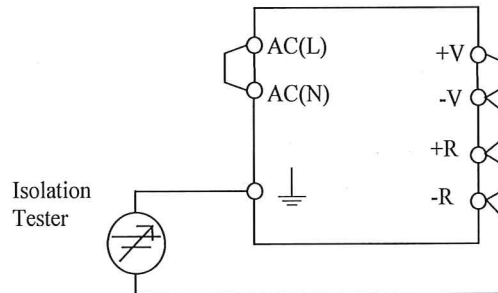

4-10. Withstand Voltage

This series is designed to withstand 3.0kVAC between input and output, 2.0kVAC between input and \perp terminal and 500VAC between output and \perp terminal each for 1 minute. When testing withstand voltage, set current limit of withstand voltage test equipment at 20mA (Output - \perp terminal:100mA). The applied voltage must be gradually increased from zero to testing value and then gradually decreased for shut down. When timer is used, the power supply may be damaged by high impulse voltage at switch on and off timing. Connect input and output as follows.

Input - Output (dotted line) : 3.0kVAC, 1min (20mA)

Output - \perp terminal : 500VAC, 1min (100mA)

Input - \perp terminal (solid line) : 2.0kVAC, 1min (20mA)

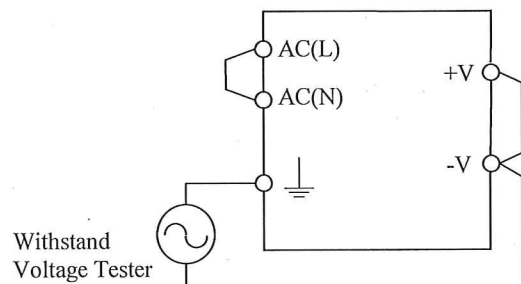
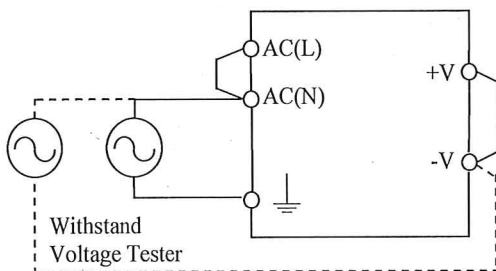

RWS600B/FO

Input - Output (dotted line) : 3.0kVAC, 1min (20mA)
 Input - \perp terminal (solid line) : 2.0kVAC, 1min (20mA)

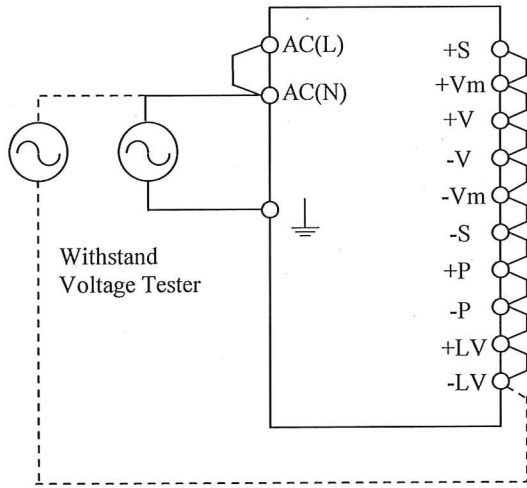

Output - \perp terminal : 500VAC, 1min (100mA)

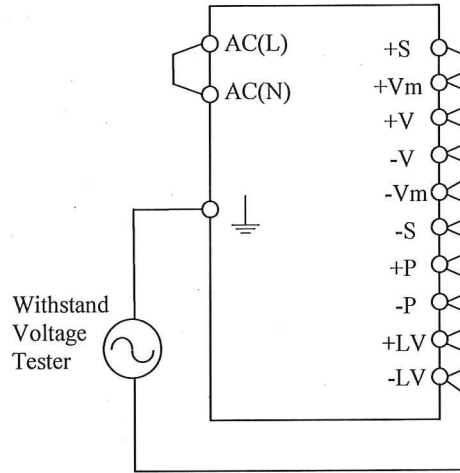

RWS600B/R

Input - Output (dotted line) : 3.0kVAC, 1min (20mA)
 Input - \perp terminal (solid line) : 2.0kVAC, 1min (20mA)

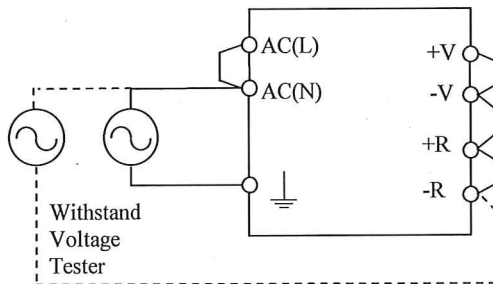

Output - \perp terminal : 500VAC, 1min (100mA)

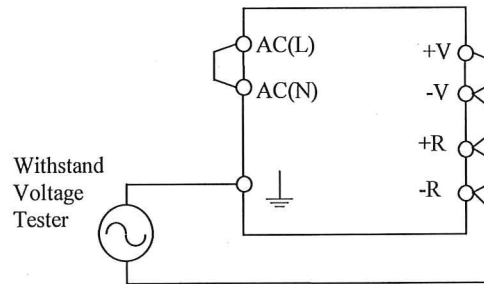

4-11. Remote Sensing (+S, -S terminal) (RWS600B Option "/FO")

Remote Sensing function is provided on option model /FO.

This function compensates voltage drop of wiring from output terminals to load terminals. Connect "+S" terminal to "+" terminal of load and "-S" terminal to "-" terminal of load with sensing wires.

The total line voltage drop (+ side line and - side line) shall be less than 0.3V.

In case that sensing line is too long, it is recommended to connect electrolytic capacitor in the following locations:

- 1) Across the load terminal,
- 2) Between "+S" terminal and "+Vm" terminal,
- 3) Between "-S" terminal and "-Vm" terminal.

Connect "+S" terminal to "+Vm" terminal, "-S" terminal to "-Vm" terminal with short pieces when remote sensing function is not used. If disconnected, OVP may be triggered.

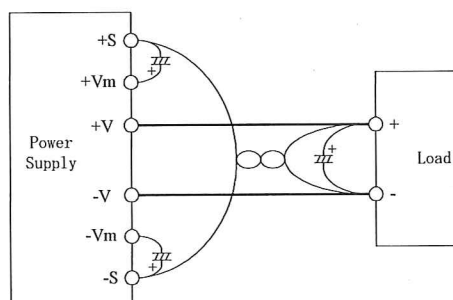

4-12. Low Output Voltage Detection Signal (LV Signal) (RWS600B Option "/FO")

Low output voltage detection signal function is provided on option model /FO . LV signal will turn "High" level to indicate the abnormal status when the output voltage drop by either brownout of the input voltage, OCP or OVP operation. The LV signal is isolated from input and output by a photo-coupler. LV signal is open collector method as shown in below.

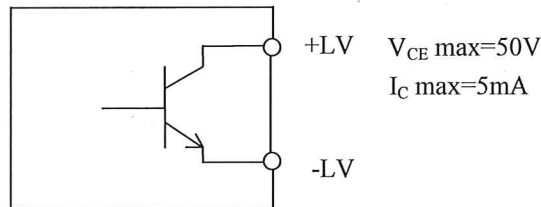

4-13. Remote ON/OFF Control (RWS600B Option "/R")

Remote ON/OFF control function is provided on option model /R.

Using this function allows the user to turn the output on and off without having to turn the AC input off and on.

It is controlled by the external voltage applied to +R and -R. This circuit is in the secondary side of the power supply unit. Never connect to primary side.

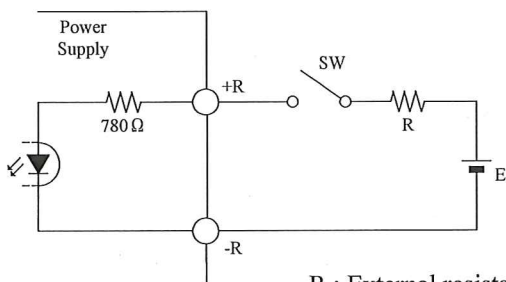

R : External resistance
 E : External voltage

The control mode is shown below.

+R & -R terminal condition	Output condition
SW ON (Higher than 4.5V)	ON
SW OFF (Lower than 0.5V)	OFF

External voltage : E	External resistance : R
4.5 ~ 12.5VDC	No required
12.5 ~ 24.5VDC	1.5kΩ

5. Mounting Method

5-1. Mounting Method

RWS100B, RWS150B

- These models are convection cooling type power supply. As consideration for the heat radiation, keep a space more than 15mm between the power supply and the peripheral parts. Also when using multiple units, keep a space more than 15mm from each other.
- The maximum allowable penetration of mounting screws is 6mm.
- Recommended torque for mounting screw
 RWS100B, RWS150B (M3 screw) : 0.49 N·m (5.0 kgf·cm)

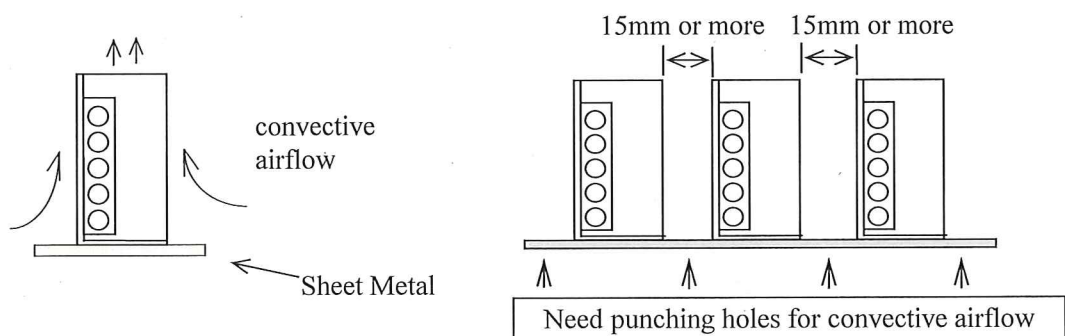

RWS300B, RWS600B

(1) These models are forced air cooling type power supply. This power supply has ventilating holes. Keep a space more than 50mm between front side and back side of the power supply from the peripheral parts. Also keep a space more than 5mm between other surfaces and the peripheral parts. Never use in the dusty environment.

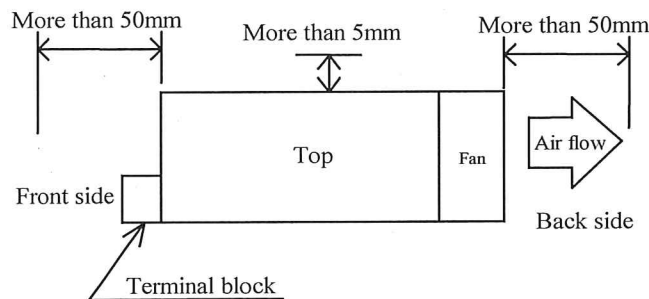
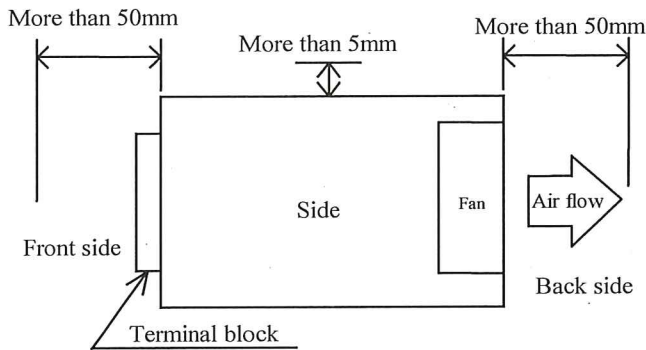

(2) The maximum allowable penetration of mounting screws is 6mm.

(3) Recommended torque for mounting screw

RWS300B(M3screw) : 0.49N·m (5.0kgf·cm)

RWS600B(M4 screw) : 1.27N·m (13.0kgf·cm)

5-2. Output Derating according to the Mounting Directions

RWS100B, RWS150B

The standard mounting is direction (A). Direction (B), (C) and (D) are also possible. Please contact us for other mounting directions.

Never use as mounting direction (E) and (F) shown below.

Refer to the output derating below, load (%) is percent of maximum output current value in a rated output voltage.

■ Mounting direction

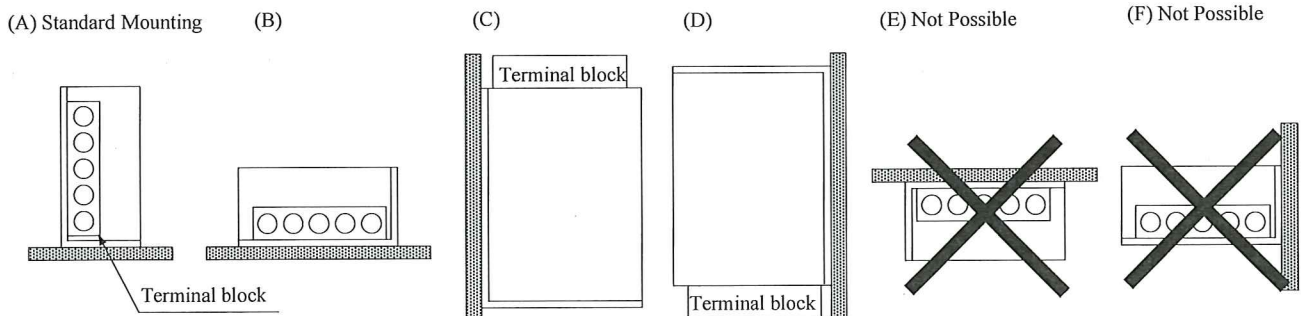

■ Output Derating

RWS100B

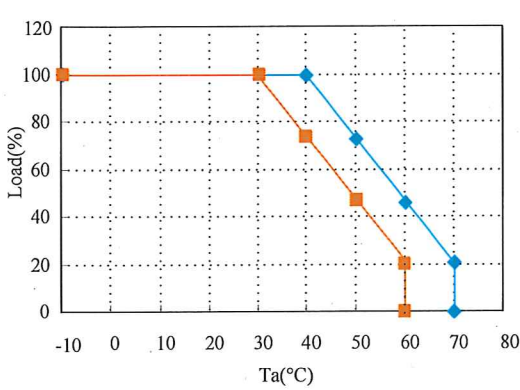

◆ Mounting (A)
 ■ Mounting (B),(C),(D)

Ta(°C)	Load (%)	
	Mounting(A)	Mounting(B),(C),(D)
-10 - +30	100	100
+40	100	73
+50	73	47
+60	46	20
+70	20	0

RWS150B

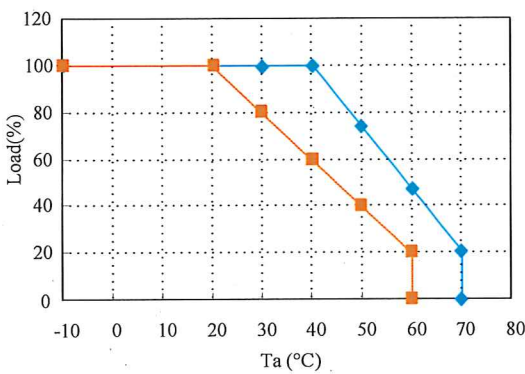

◆ Mounting (A)
 ■ Mounting (B),(C),(D)

Ta(°C)	Load (%)	
	Mounting(A)	Mounting (B),(C),(D)
-10 - +20	100	100
+30	100	80
+40	100	60
+50	73	40
+60	46	20
+70	20	0

RWS300B

The standard mounting is direction (A). Direction (B), (C) and (D) are also possible. Please contact us for other mounting directions.

Never use as mounting direction (E) and (F) shown below.

Refer to the output derating below, load (%) is percent of maximum output current value in a rated output voltage.

■ Mounting direction

(A) Standard Mounting

(B)

(C)
Terminal block

(D)

(E) Not Possible

(F) Not Possible

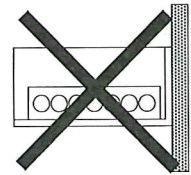
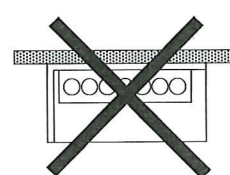
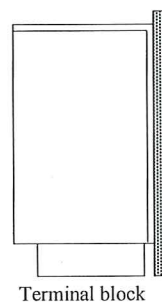
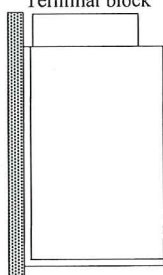
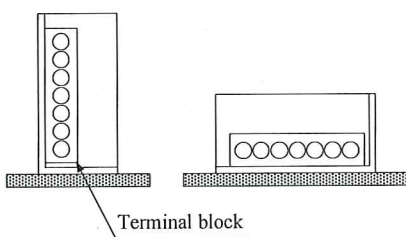

■ Output Derating

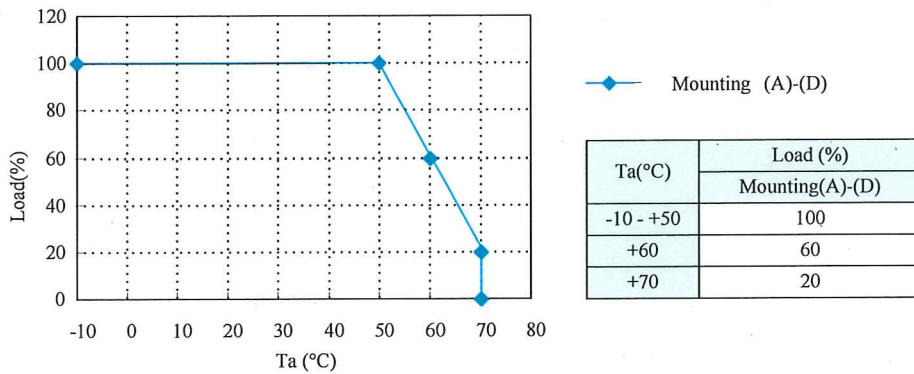

RWS600B

The standard mounting is direction (A). Direction (B), (C) and (D) are also possible. Please contact us for other mounting directions.

Never use as mounting direction (E) and (F) shown below.

Refer to the output derating below, load (%) is percent of maximum output current value in a rated output voltage.

■ Mounting direction

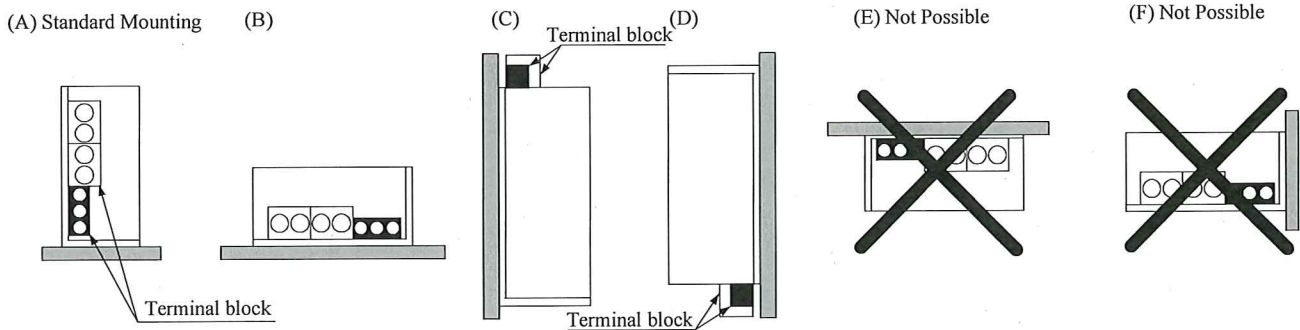

■ Output Derating

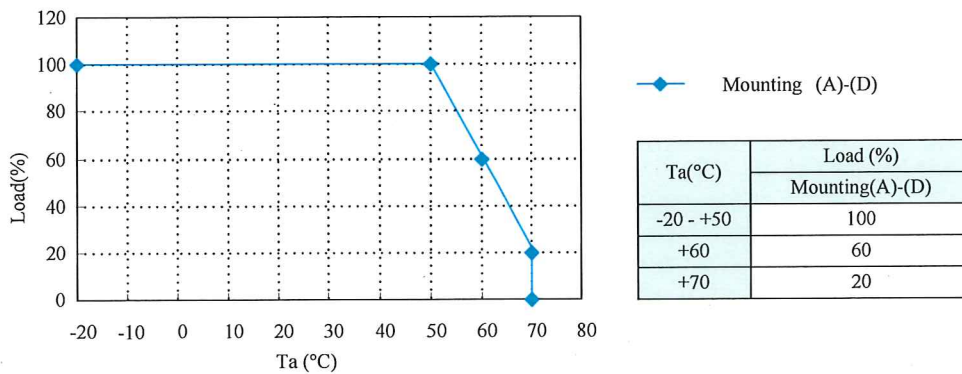

5-3. Output Derating according to the Input Voltage

Load (%) is percent of maximum output current value in a rated output voltage.

RWS100B, RWS150B

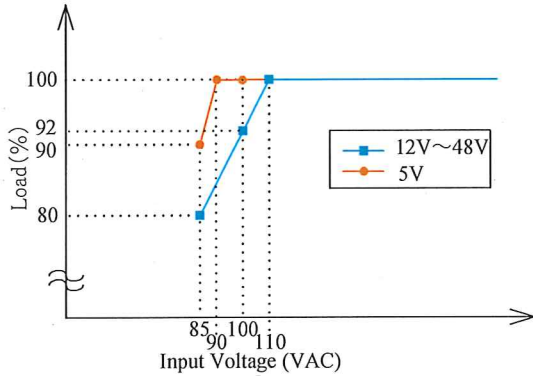

RWS300B, RWS600B

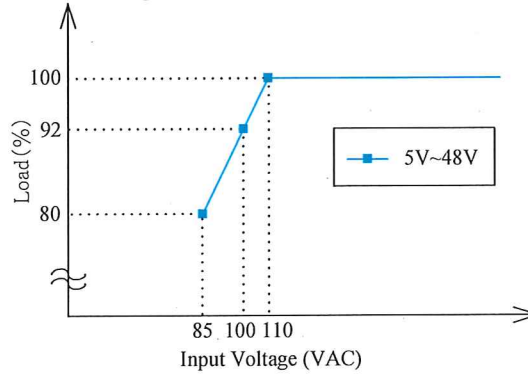

6. Wiring Method

- (1) The output load line and input line shall be separated, and use all lines as thick and short as possible to make lower impedance. The output load line and input line shall be twisted or use shielded wire to improve noise sensitivity.
- (2) Remote sensing lines and remote ON/OFF control lines shall be twisted or use shielded wire, and separated from the output lines. (RWS600B Option)
- (3) Noise can be eliminated by attaching a capacitor to the load terminals.
- (4) The recommended wire type, torque and crimp-type terminal :

MODEL	Recommended Wire	Recommended torque	Recommended crimp-type terminal		
			D (MAX)	t (MAX)	Mounting pieces (MAX)
RWS100B RWS150B RWS300B	AWG12-22	M3.5 Screws $1.0\text{N}\cdot\text{m}(10.2\text{kgf}\cdot\text{cm})\sim 1.6\text{N}\cdot\text{m}(16.3\text{kgf}\cdot\text{cm})$	8.1mm	1.0mm	1 piece
				0.8mm	2 pieces
RWS600B	—	Output terminal M5 Screws $2.2\text{N}\cdot\text{m}(22.4\text{kgf}\cdot\text{cm})\sim 2.8\text{N}\cdot\text{m}(28.6\text{kgf}\cdot\text{cm})$	—		
	AWG12-22	Other terminal M3.5 Screws $1.0\text{N}\cdot\text{m}(10.2\text{kgf}\cdot\text{cm})\sim 1.6\text{N}\cdot\text{m}(16.3\text{kgf}\cdot\text{cm})$	8.1mm	1.0mm	1 piece
				0.8mm	2 pieces

Note 1 : When using separate loads, use of two pcs. of 0.8mm thick crimp-type terminal is recommended.

Note 2 : For recommended wire type, refer to wire maker recommended allowable current and voltage drop.

Especially for 5V models, output current is large. Thick diameter wire is recommended.

Recommended wire type and crimp-type terminal for RWS600B vary depending on use conditions. Choice most appropriate wire type and crimp-type terminal by refer to wire maker recommended allowable current and voltage drop.

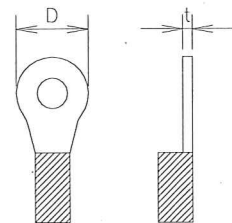

(5) Radiated Emission (RWS600B)

It is recommended to use the clamp filter to meet EN55011/EN5502-B, FCC-ClassB, VCCI-B.
 The unit might meet the standard without using the clamp filter depend on wiring and mounting unit installed conditions (for example, by using other external input filter or using at light load etc.).
 Evaluate well by the system is recommended.

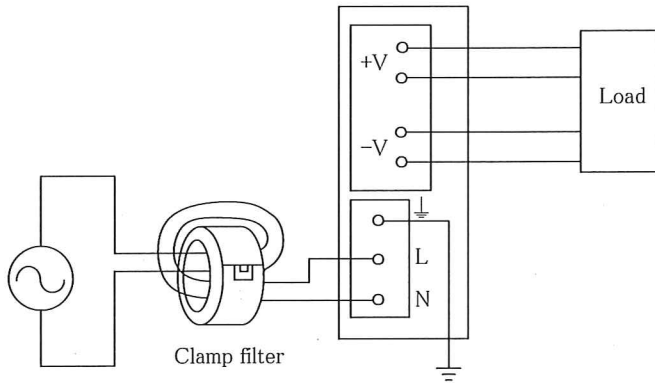

Note : Recommended clamp filter is ZCAT3035-1330 (TDK). Winding input wire around the clamp filter 2 turn.

7. The life expectancy

The life expectancy of the power supply is as follows.
 The life expectancy is dependent on the lifetime of electrolytic capacitor or the fan.
 The life expectancy is not a guaranteed value, please consider as a reference.
 Do not use the product which passed over the life expectancy.
 There is a risk of unexpected output shutdown or specifications may not be satisfied.
 Please contact us for maintenance or exchange the product which passed over the life expectancy.
 The life expectancy of power supply is calculated in condition of rated input voltage and 24-hour continuous operation.
 Load (%) is percent of maximum output current in a rated output voltage.

◇ **RWS100B**

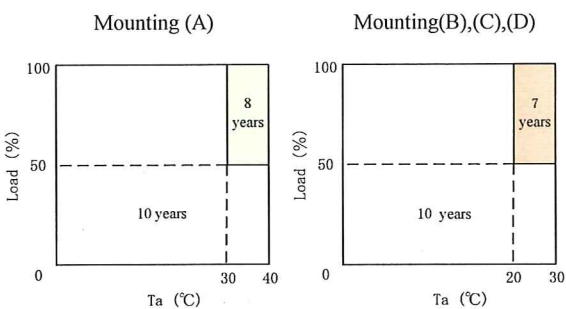

◇ **RWS150B**

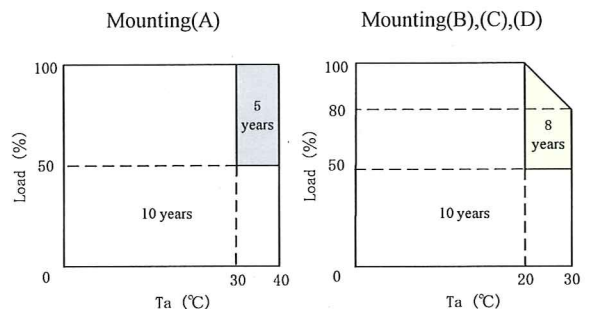

◇RWS300B

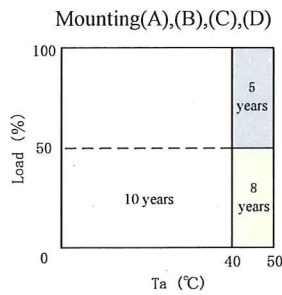

◇RWS600B

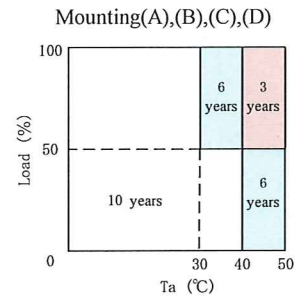

The following figure shows the life expectancy of the fan (RWS300B, RWS600B)

The difference between the intake temperature and the exhaust temperature of the power supply at 100%

RWS300B : 5°C

RWS600B : 10°C

Measurement point of fan exhaust temperature

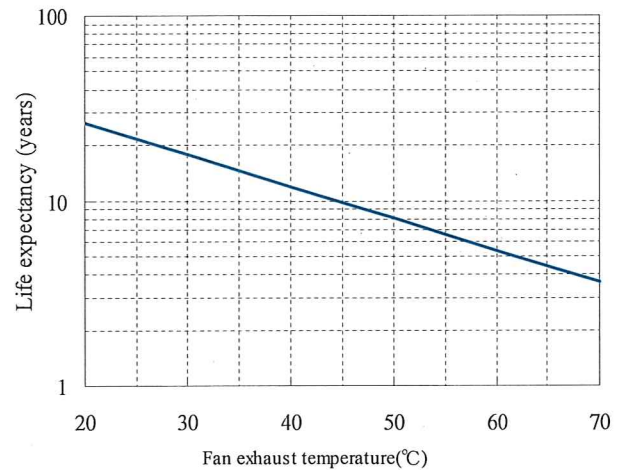
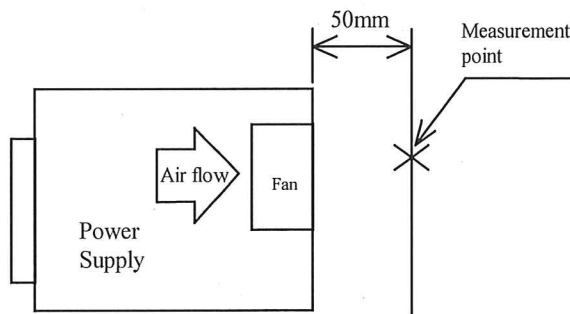

8. External Fuse Rating

Refer to the following fuse rating when selecting the external input fuse.

Surge current flows when input turn on. Use slow-blow fuse or time-lag fuse. Fast-blow fuse can not be used.

Fuse rating is specified by inrush current value at input turn on.

Do not select the fuse according to actual input current (rms.) values.

RWS100B	: 3.15A
RWS150B	: 5A
RWS300B	: 10A
RWS600B	: 15A

9. Before concluding that the unit is at fault...

Before concluding that the unit is at fault, make the following checks.

- (1) Check if the rated input voltage is connected.
- (2) Check if the wiring of input and output is correct.
- (3) Check if the wire size is not too thin.
- (4) Check if the output voltage control (V.ADJ) is properly adjusted.
- (5) Check if the Remote ON/OFF control connector is not opened, when use Remote ON/OFF control function.
- (6) Check if the output current and output power does not over specifications.
- (7) Audible noise can be heard when input voltage waveform is not sinusoidal wave
- (8) Audible noise can be heard during Dynamic-Load operation.
- (9) Ensure that large capacitor is not connected on the output side.

Please use within maximum capacitance shown below.

If connecting more than the following capacitance value is required, please contact us for details.

MODEL	Maximum external capacitance			
	5V	12V	24V	48V
RWS100B, RWS150B	10,000uF			

MODEL	Maximum external capacitance					
	5V	12V	15V	24V	36V	48V
RWS300B, RWS600B	10,000uF					

10. Warranty Period

Warranty Period applies for Mounting (A) and the number of output ON/OFF is only once a day.

Do not exceed its derating of maximum load.

For damages occurring at normal operation within this warranty period, repair is free of charge.

Please contact our sales office for warranty in other mounting directions if required.

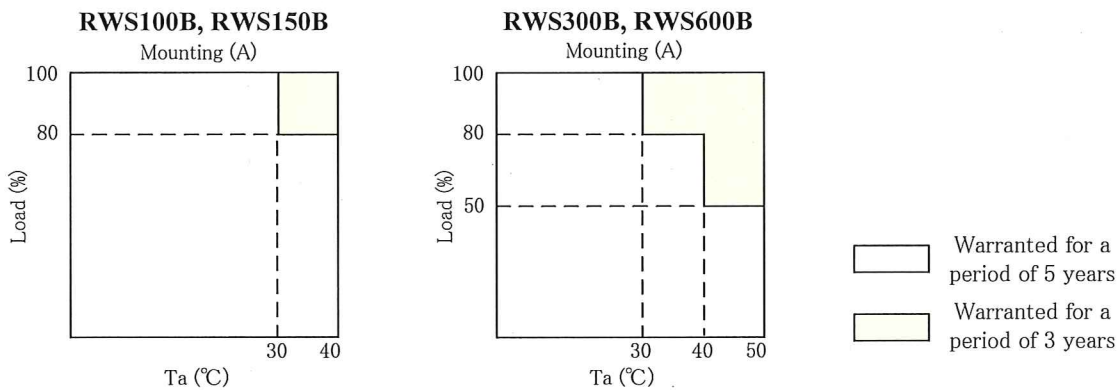

Following cases are not covered by warranty

- (1) Improper usage like dropping products, applying shock and defects from operation exceeding specification of the unit.
- (2) Defects resulting from natural disaster (fire, flood etc.)
- (3) Unauthorized modifications or repair.