

Electronic device circuit breaker - CB E1 24DC/1A SI-R P - 2905799

Please be informed that the data shown in this PDF Document is generated from our Online Catalog. Please find the complete data in the user's documentation. Our General Terms of Use for Downloads are valid (<http://phoenixcontact.com/download>)



Electronic device circuit breaker, 1-pos., active current limitation, inverted status output and control input, plug for base element.

The figure shows the CB E1 24DC/10A SI-R P version

Product Features

- ✓ Compact design with precise nominal current levels
- ✓ Modular expansion possible thanks to the uniform, plug-in housing concept
- ✓ Sophisticated remote signaling concept enables monitoring from any location
- ✓ The reset input can be switched by means of remote control
- ✓ Active current limitation, even when switching capacitive loads
- ✓ Supply/remote signaling can be bridged with CLIPLINE complete accessories



Key Commercial Data

Packing unit	1 pc
Custom tariff number	85362010
Country of origin	Germany

Technical data

Dimensions

Height	45 mm
Width	12.3 mm
Depth	52 mm
Complete module height	90 mm
Complete module width	12.3 mm
Complete module depth	77.3 mm

Ambient conditions

Ambient temperature (operation)	-25 °C ... 50 °C (non-condensing)
---------------------------------	-----------------------------------

Electronic device circuit breaker - CB E1 24DC/1A SI-R P - 2905799

Technical data

Ambient conditions

Ambient temperature (storage/transport)	-40 °C ... 70 °C
Humidity test	96 h, 95% RH, 40°C
Degree of protection	IP30 (Actuation area)

General

Flammability rating according to UL 94	V0
Mounting type	On base element
Color	gray
Number of positions	1
Pollution degree	2
Type	Male

Electrical data

Fuse type	Electronic
Rated surge voltage	0.5 kV
Operating voltage	24 V DC
	18 V DC ... 30 V DC
Nominal current I_N	1 A
Rated insulation voltage U_i	30 V (Load circuit)
Required backup fuse	not required, integrated failsafe element
Active current limitation	typ. $1.25 \times I_N$
Contact type	Without electrical isolation
Closed circuit current I_0	typ. 8 mA (When switched on)
	typ. 11 mA (With status output)
Temperature derating	1 A (at 50°C)
Tripping method	E (electronic)
Dielectric strength	max. 30 V DC (Load circuit)
Voltage drop	140 mV (at I_N)
Contact type	Without electrical isolation
Shutdown time load circuit	800 ms (see time/current characteristic curve)
Max. capacitive load load circuit	20000 μ F
Output voltage status output	24 V DC
Output current status output	max. 0.2 A (Short-circuit-proof)
Input voltage reset input	max. 30 V DC
Current consumption reset input	typ. 2.6 mA (at 24 V DC)
Auxiliary type of contact	Positive-switching signal output

Standards and Regulations

Standards/specifications	UL 2367 UL recognized
--------------------------	-----------------------

Electronic device circuit breaker - CB E1 24DC/1A SI-R P - 2905799

Technical data

Standards and Regulations

	UL 508 UL/C-UL listed
	EMV EN 61000-6-3 Noise emission
	EMV EN 61000-6-2 Noise immunity

Classifications

eCl@ss

eCl@ss 4.0	27141116
eCl@ss 4.1	27141116
eCl@ss 5.0	27141116
eCl@ss 5.1	27141116
eCl@ss 6.0	27141116
eCl@ss 7.0	27141116
eCl@ss 8.0	27141116

ETIM

ETIM 3.0	EC000899
ETIM 4.0	EC000899
ETIM 5.0	EC000899

UNSPSC

UNSPSC 6.01	30211812
UNSPSC 7.0901	39121411
UNSPSC 11	39121411
UNSPSC 12.01	39121411
UNSPSC 13.2	39121411

Approvals

Approvals

Approvals

UL Recognized / UL Listed / cUL Listed / EAC / cULus Listed

Ex Approvals

Electronic device circuit breaker - CB E1 24DC/1A SI-R P - 2905799

Approvals

Approvals submitted

Approval details

UL Recognized
UL Listed
cUL Listed
EAC
cULus Listed

Drawings

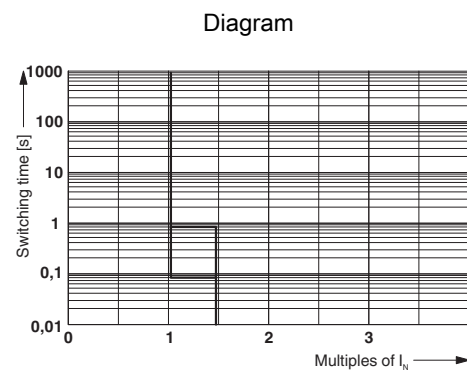
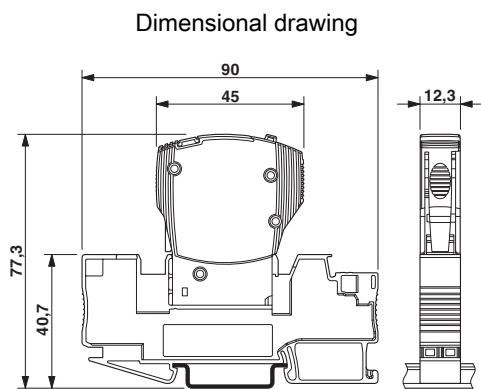

The figure shows the complete module consisting of a base element and connector

Trigger characteristic

Electronic device circuit breaker - CB E1 24DC/1A SI-R P - 2905799

Application drawing

