

THIS DOCUMENT IS THE PROPERTY OF
KEYSTONE ELECTRONICS CORP. AND
SHALL NOT BE REPRODUCED, DISTRIBUTED
OR USED AS A BASIS FOR MANUFACTURE
WITHOUT PRIOR WRITTEN PERMISSION
FROM KEYSTONE ELECTRONICS CORP.

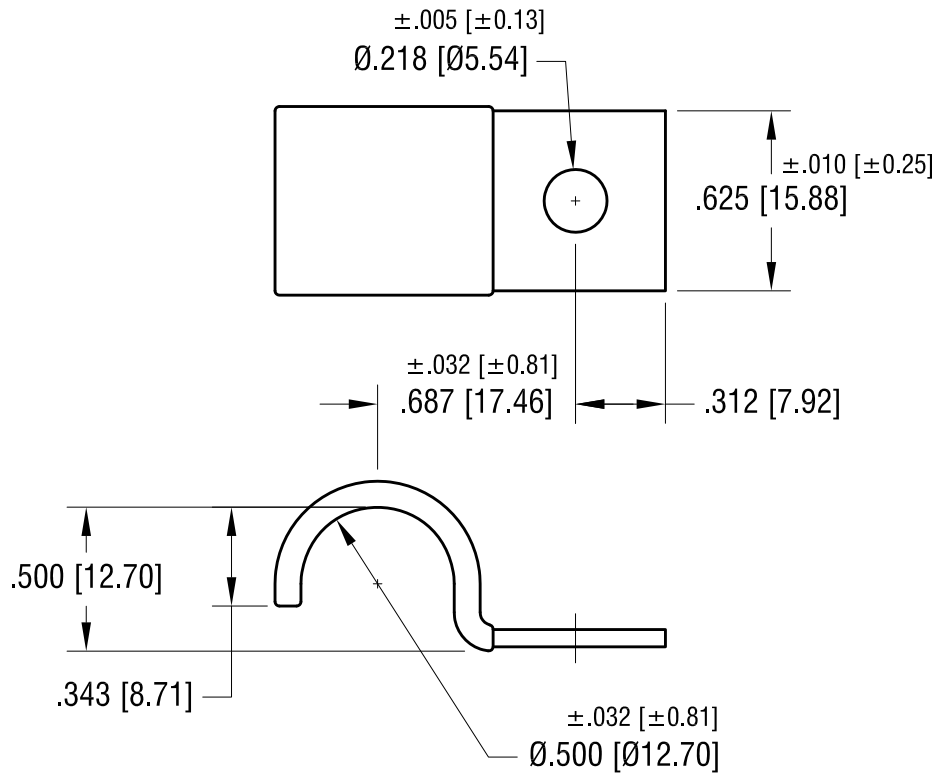

KEYSTONE ELECTRONICS CORP.

www.keyelco.com • ASTORIA, N.Y. 11105-2017 • Tel (718) 956-8900

PART NAME

INSULATED STEEL HALF CLAMP

MATERIAL

.060 [1.52] TH'K STEEL, BLACK VINYL

FINISH

ZINC PLATE
CLEAR CHROMATE

DRN BY

BOONE

DATE

7.20.05

APP'D

LN

SCALE

1.5X

10.18.06 CHANGE AS PER ECN 06-072

A

TOLERANCES

INCH [MM]

CODE

DWG NO.

DECIMAL ±.015 [±0.38]

C

ANGULAR ± 1°
UNLESS OTHERWISE SPECIFIED

8165

DATE

DESCRIPTION

REV.