

RTAN SERIES

Three-Phase External Noise Prevention Filter (For Immunity)



FEATURES

- Self-tightening screws and an open/close type cover make wiring work easier.
- Small and light plastic body.
- Low-profile design.
- Best for high-voltage pulse noise prevention.
- DIN rail installation compatible type is also available.
- Compliant with RoHS directives.

SAFETY STANDARDS

UL1283	File No. E62388
EN60939	Licence Ref. No. SE/07115-5

PRODUCT IDENTIFICATION

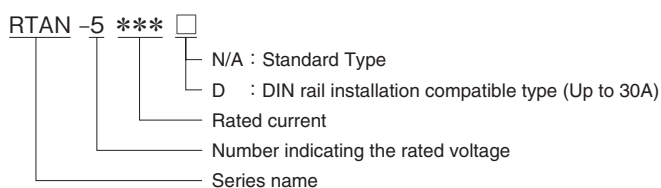

CIRCUIT DIAGRAM

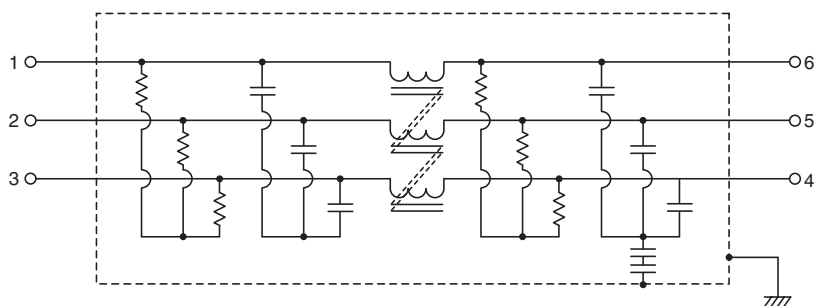

• Conformity to RoHS Directive: This means that, in conformity with EU Directive 2002/95/EC, lead, cadmium, mercury, hexavalent chromium, and specific bromine-based flame retardants, PBB and PBDE, have not been used, except for exempted applications.

• All specifications are subject to change without notice.

ELECTRICAL CHARACTERISTICS

Part No.	Rated voltage (AC/DC)	Rated current (AC/DC)	Withstand voltage	Insulation resistance	Leakage current	Operating temperature range	With derating over	DC resistance (mΩ)	Attenuation frequency range (MHz)		Weight (kg)
									Common mode	Differential mode	
									at 25dB	at 25dB	
RTAN-5006	500V	6A	AC.2500V 60s [Between line to ground]	100MΩ min. [DC.500V/ 1min]	2.5mA max. [250V/60Hz]	-25 to +85°C	50°C	145 max.	0.2 to 10	0.2 to 30	0.36
RTAN-5010		10A						60 max.	0.3 to 10	0.2 to 30	0.36
RTAN-5020		20A						25 max.	0.4 to 10	0.2 to 30	0.57
RTAN-5030		30A						13 max.	0.6 to 10	0.3 to 30	0.57
RTAN-5040		40A						10 max.	0.5 to 8	0.2 to 30	1.12
RTAN-5050		50A						7 max.	0.6 to 10	0.3 to 30	1.12
RTAN-5060		60A						5 max.	0.7 to 10	0.3 to 30	1.12

DERATINGS

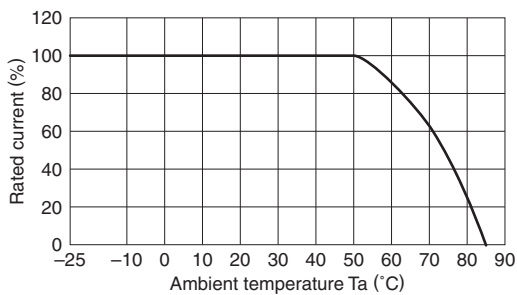

SHAPES AND DIMENSIONS

RTAN-5006/5010

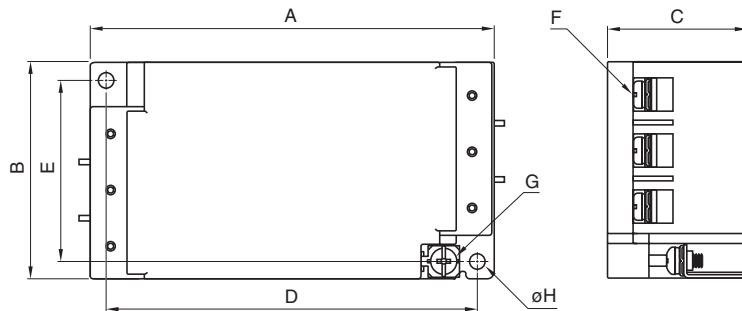

RTAN-5020/5030/5040/5050/5060

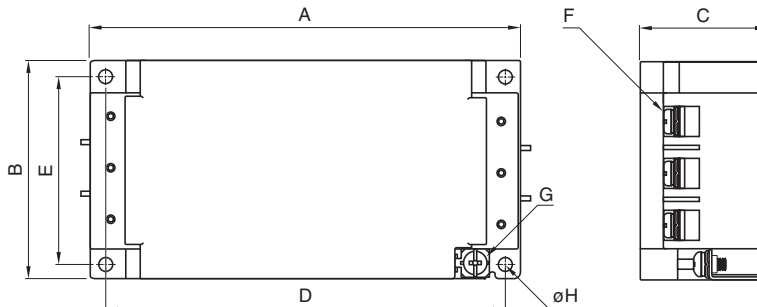

Dimensions in mm

Part No.	A	B	C	D	E	F	G	φH	Recommended clamping torque
RTAN-5006	120	63	42	110	53	M4	M4	4.5	M4 : 1.27N · m M5 : 2.5N · m
RTAN-5010									
RTAN-5020	140	70	42	130	60	M4	M4	4.5	
RTAN-5030									
RTAN-5040									
RTAN-5050	170	90	54	160	80	M5	M4	4.5	
RTAN-5060									

RTAN-5006D/5010D

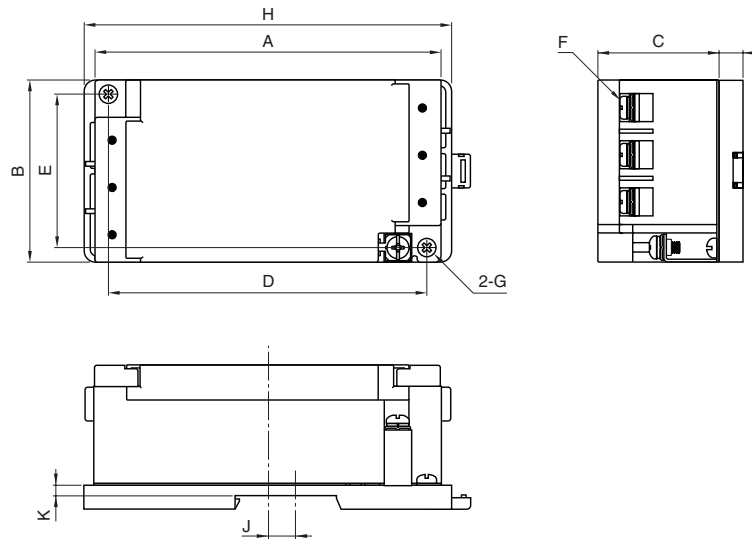

RTAN-5020D/5030D

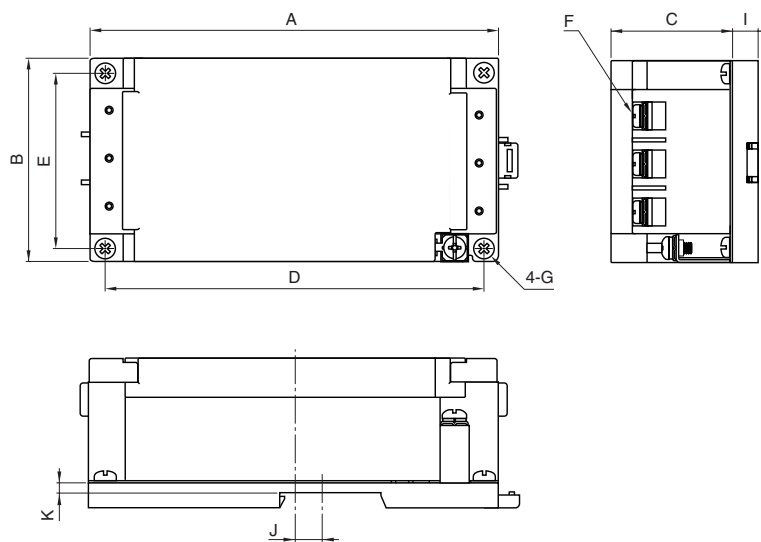

Dimensions in mm

Part No.	A	B	C	D	E	F	G	H	I	J	K
RTAN-5006D	120	63	42	110	53	M4	M4	127	8.4	6	3.5
RTAN-5010D								-	8.4	12.5	3.5
RTAN-5020D	140	70	42	130	60	M4	M4	-	8.4	12.5	3.5
RTAN-5030D								-	8.4	12.5	3.5

ATTENUATION vs. FREQUENCY CHARACTERISTICS

RTAN-5006

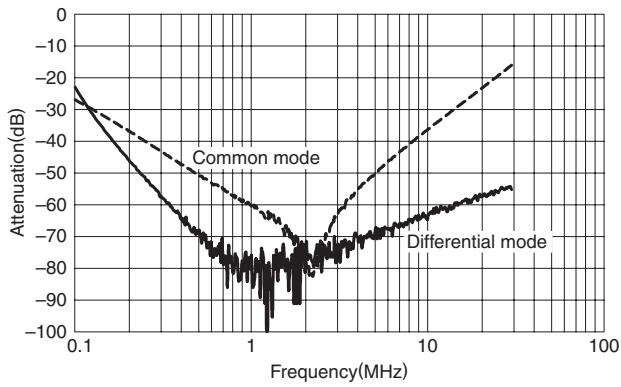

RTAN-5010

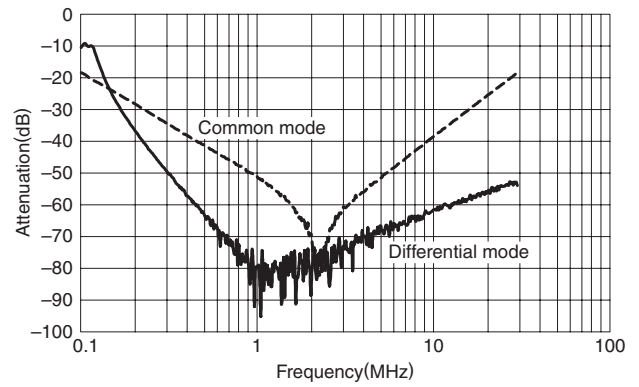

RTAN-5020

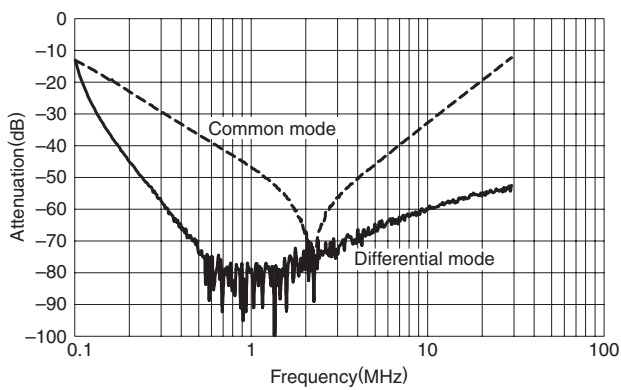

RTAN-5030

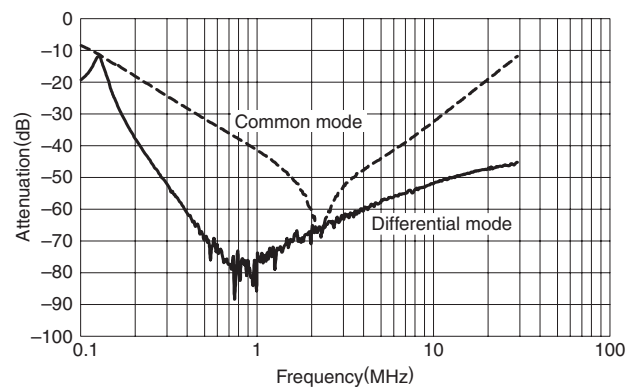

RTAN-5040

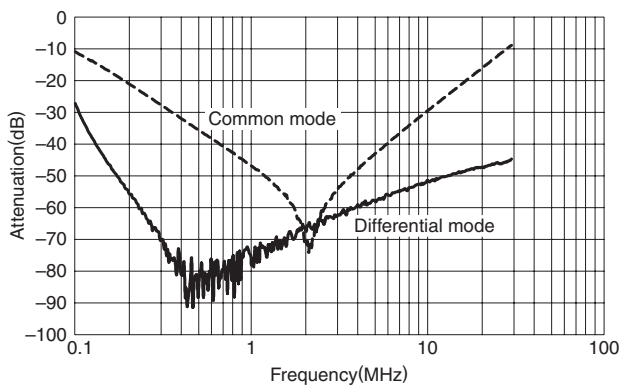

RTAN-5050

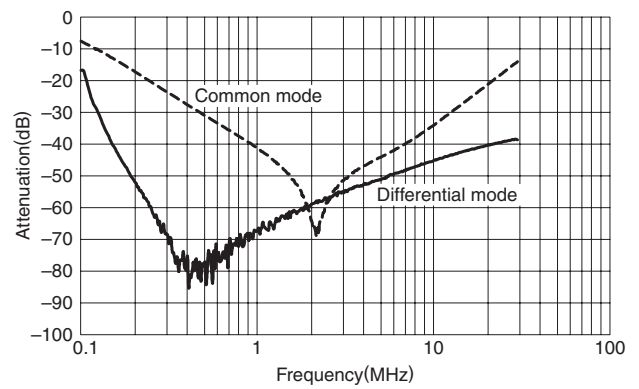

RTAN-5060

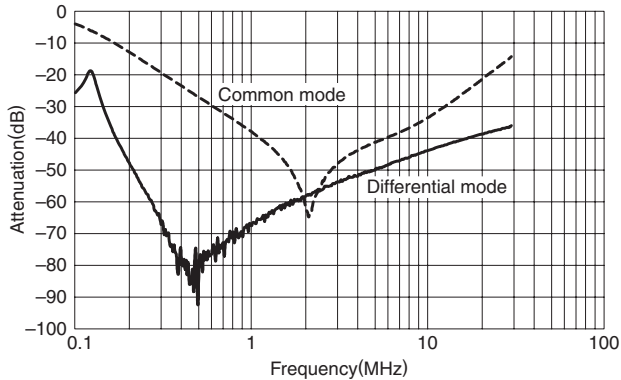

PULSE ATTENUATION CHARACTERISTICS

RTAN-5006

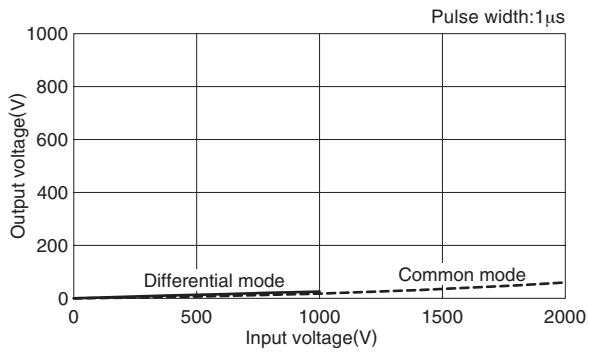

RTAN-5010

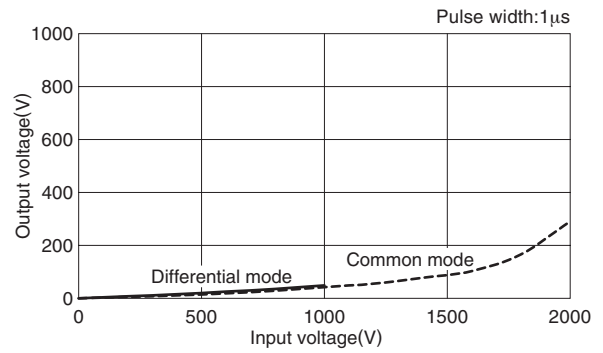

RTAN-5020

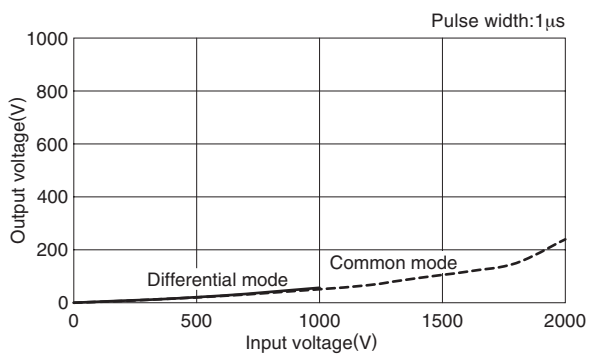

RTAN-5030

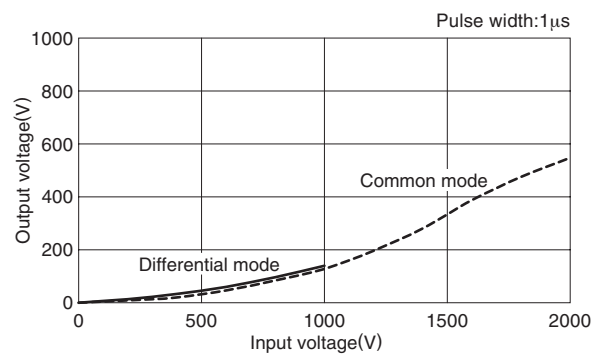

RTAN-5040

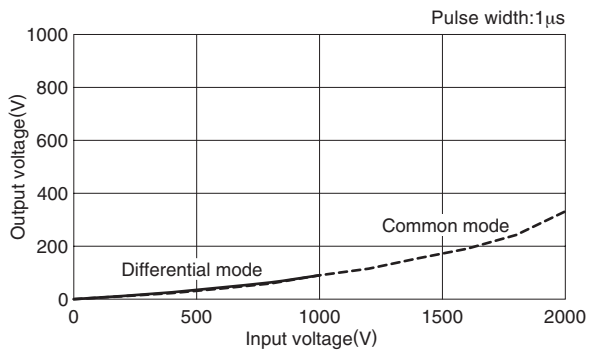

RTAN-5050

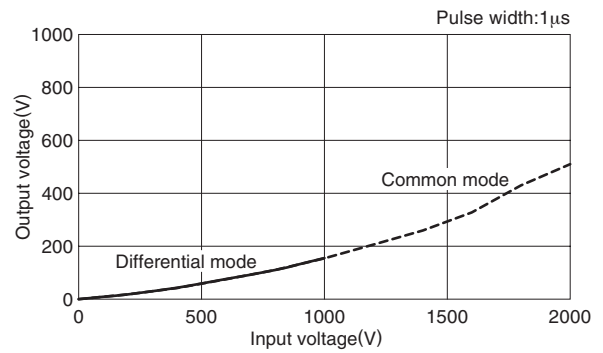

RTAN-5060

