

FDR8508P

Dual P-Channel, Logic Level, PowerTrench™ MOSFET

General Description

These P-Channel 2.5V specified MOSFETs are produced using Fairchild Semiconductor's advanced PowerTrench process that has been especially tailored to minimize the on state resistance and yet maintain low gate charge for superior switching performance.

Applications

- Load switch
- DC/DC converter
- Motor driving

Features

- -3.0 A, -30 V. $R_{DS(ON)} = 0.052\Omega @ V_{GS} = -10V$
 $R_{DS(ON)} = 0.086\Omega @ V_{GS} = -4.5V.$
- Low gate charge. (8nC typical).
- High performance trench technology for extremely low $R_{DS(ON)}$
- High power and current handling capability.
- Small footprint (38% smaller than a standard SO-8); low profile package (1 mm thick); power handling capability similar to SO-8.

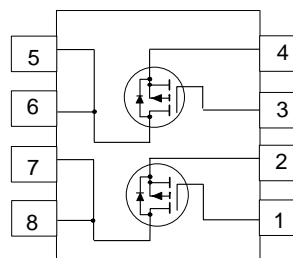
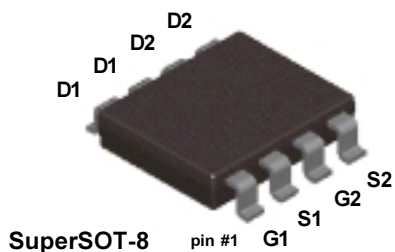

Absolute Maximum Ratings T_A = 25°C unless otherwise noted

Symbol	Parameter	FDR8508P	Units
V _{DSS}	Drain-Source Voltage	-30	V
V _{GSS}	Gate-Source Voltage	±20	V
I _D	Drain Current - Continuous (Note 1a) - Pulsed	-3	A
		-20	
P _D	Power Dissipation	0.8	W
T _J , T _{stg}	Operating and Storage Junction Temperature Range	-55 to +150	°C

Thermal Characteristics

R _{θJA}	Thermal Resistance, Junction-to-Ambient (Note 1a)	156	°C/W
R _{θJC}	Thermal Resistance, Junction-to-Case (Note 1)	40	°C/W

Package Marking and Ordering Information

Device Marking	Device	Reel Size	Tape Width	Quantity
.8508	FDR8508P	13"	12mm	3000 units

Electrical Characteristics

$T_A = 25^\circ\text{C}$ unless otherwise noted

Symbol	Parameter	Test Conditions	Min	Typ	Max	Units
--------	-----------	-----------------	-----	-----	-----	-------

Off Characteristics

BV_{DSS}	Drain-Source Breakdown Voltage	$V_{GS} = 0\text{ V}, I_D = -250\ \mu\text{A}$	-30			V
$\Delta BV_{DSS}/\Delta T_J$	Breakdown Voltage Temperature Coefficient	$I_D = -250\ \mu\text{A}$, Referenced to 25°C		24		mV/ $^\circ\text{C}$
I_{DSS}	Zero Gate Voltage Drain Current	$V_{DS} = -24\text{ V}, V_{GS} = 0\text{ V}$			-1	μA
I_{GSSF}	Gate-Body Leakage Current	$V_{GS} = 20\text{ V}, V_{DS} = 0\text{ V}$			100	nA
I_{GSSR}	Gate-Body Leakage Current	$V_{GS} = -20\text{ V}, V_{DS} = 0\text{ V}$			-100	nA

On Characteristics (Note 2)

$V_{GS(th)}$	Gate Threshold Voltage	$V_{DS} = V_{GS}, I_D = -250\ \mu\text{A}$	-1	-1.8	-3	V
$\Delta V_{GS(th)}/\Delta T_J$	Gate Threshold Voltage Temperature Coefficient	$I_D = -250\ \mu\text{A}$, Referenced to 25°C		-4		mV/ $^\circ\text{C}$
$R_{DS(on)}$	Static Drain-Source On-Resistance	$V_{GS} = -10\text{ V}, I_D = -3\text{ A}$ $V_{GS} = -10\text{ V}, I_D = -3\text{ A}, T_J = 125^\circ\text{C}$ $V_{GS} = -4.5\text{ V}, I_D = -2.3\text{ A}$		0.040 0.057 0.058	0.052 0.078 0.086	Ω Ω Ω
$I_{D(on)}$	On-State Drain Current	$V_{GS} = -10\text{ V}, V_{DS} = -5\text{ V}$	-20			A
g_{FS}	Forward Transconductance	$V_{DS} = -5\text{ V}, I_D = -3\text{ A}$		9		mS

Dynamic Characteristics

C_{iss}	Input Capacitance	$V_{DS} = -15\text{ V}, V_{GS} = 0\text{ V}, f = 1.0\text{ MHz}$		750		pF
C_{oss}	Output Capacitance			220		pF
C_{riss}	Reverse Transfer Capacitance			100		pF

Switching Characteristics (Note 2)

$t_{d(on)}$	Turn-On Delay Time	$V_{DD} = -15\text{ V}, I_D = -1\text{ A},$ $V_{GS} = -10\text{ V}, R_{GEN} = 6\ \Omega$		12	22	ns
t_r	Turn-On Rise Time			14	25	ns
$t_{d(off)}$	Turn-Off Delay Time			24	38	ns
t_f	Turn-Off Fall Time			16	27	ns
Q_g	Total Gate Charge	$V_{DS} = -15\text{ V}, I_D = -3\text{ A},$ $V_{GS} = -5\text{ V},$		8	12	nC
Q_{gs}	Gate-Source Charge			1.8		nC
Q_{gd}	Gate-Drain Charge			3		nC

Drain-Source Diode Characteristics and Maximum Ratings

I_S	Maximum Continuous Drain-Source Diode Forward Current				-0.67	A
V_{SD}	Drain-Source Diode Forward Voltage	$V_{GS} = 0\text{ V}, I_S = -0.67\text{ A}$ (Note 2)		-0.75	-1.2	V

Notes:

- $R_{\theta JA}$ is the sum of the junction-to-case and case-to-ambient thermal resistance where the case thermal reference is defined as the solder mounting surface of the drain pins. $R_{\theta JC}$ is guaranteed by design while $R_{\theta CA}$ is determined by the user's board design. $R_{\theta JA}$ shown below for single device operation on FR-4 board install air.



156 $^\circ\text{C/W}$ when mounted on a 0.0025 in² pad of 2oz copper.

Scale 1 : 1 on letter size paper

- Pulse Test: Pulse Width $\leq 300\ \mu\text{s}$, Duty Cycle $\leq 2.0\%$.

Typical Characteristics

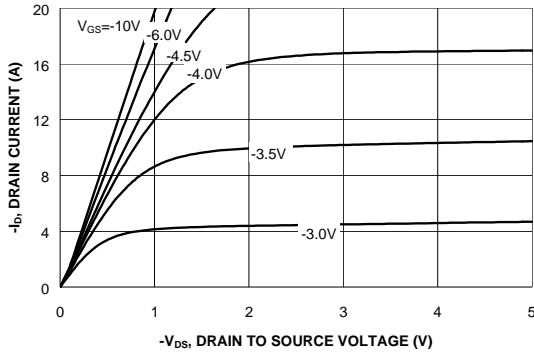

Figure 1: On-Region Characteristics

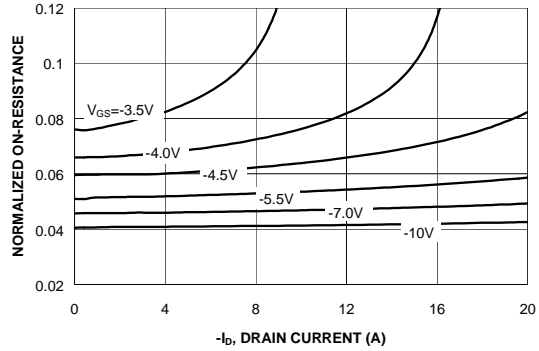

Figure 2: On-Resistance Variation vs Drain Current and Gate Voltage

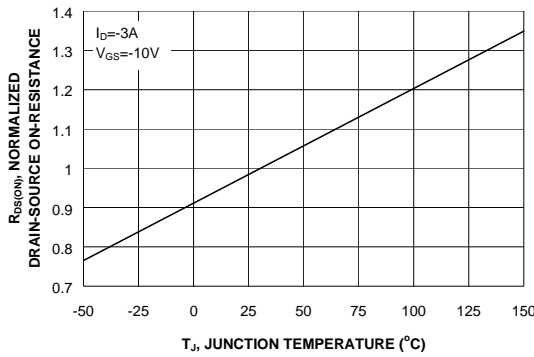

Figure 3: On-Resistance Variation vs Temperature

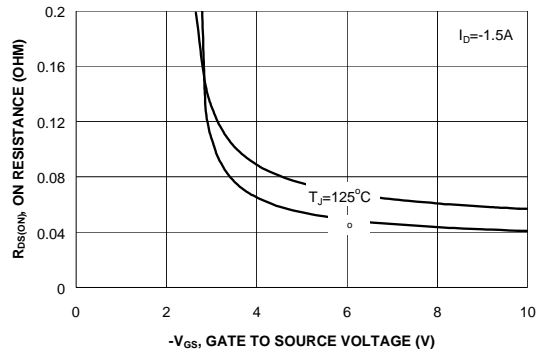

Figure 4: On-Resistance Variation vs Gate-To-Source Voltage

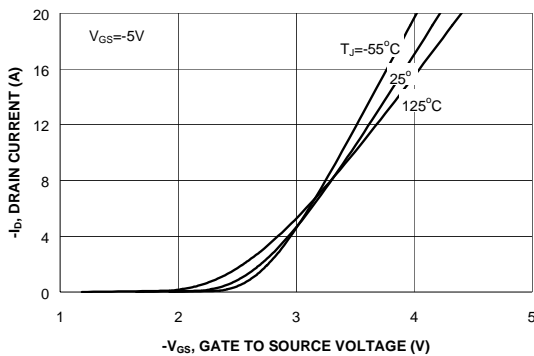

Figure 5: Transfer Characteristics

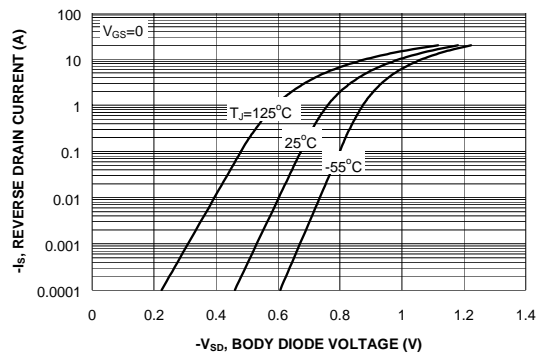

Figure 6: Body Diode Forward Voltage Variation vs Source Current and Temperature

Typical Characteristics (continued)

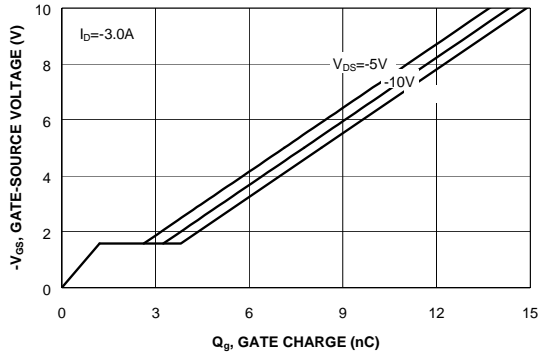

Figure 7: Gate-Charge Characteristics

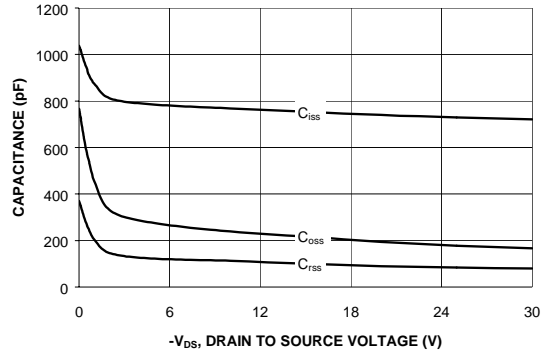

Figure 8: Capacitance Characteristics

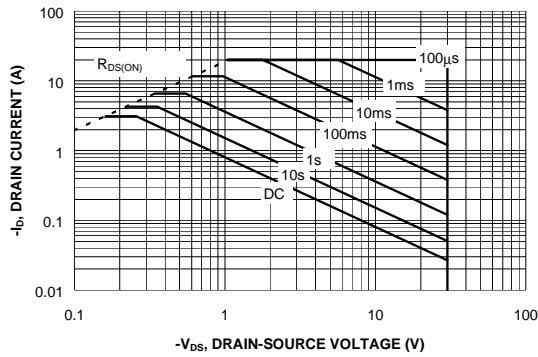

Figure 9: Maximum Safe Operating Area

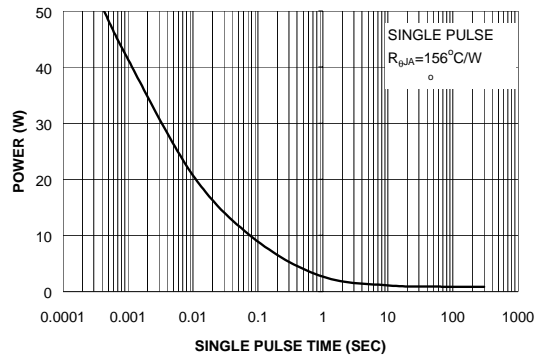

Figure 10: Single Pulse Maximum Power Dissipation

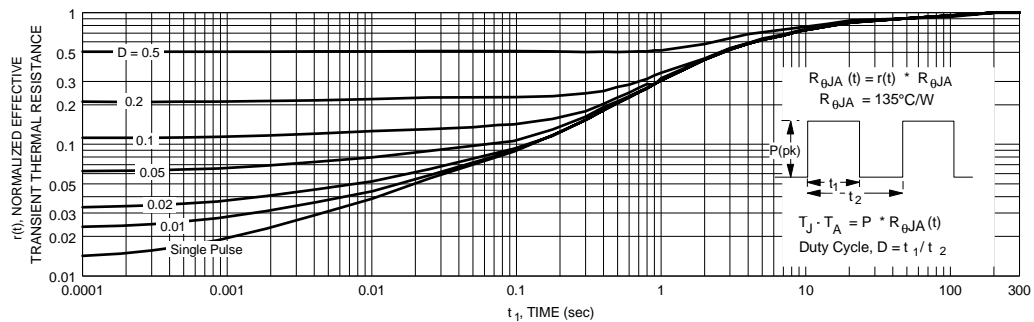

Figure 11. Transient Thermal Response Curve.

Thermal characterization performed using the conditions described in Note 1c.
Transient thermal response will change depending on the circuit board design.

SuperSOT™-8 Tape and Reel Data and Package Dimensions



SSOT-8 Packaging Configuration: Figure 1.0

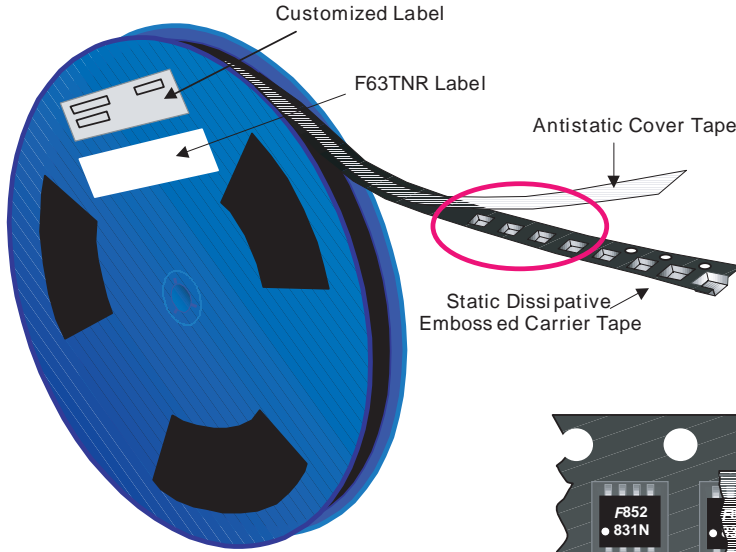

Packaging Description:

SSOT-8 parts are shipped in tape. The carrier tape is made from a dissipative (carbon filled) polycarbonate resin. The cover tape is a multilayer film (Heat Activated Adhesive in nature) primarily composed of polyester film, adhesive layer, sealant, and anti-static sprayed agent. These reeled parts in standard option are shipped with 3,000 units per 13" or 330cm diameter reel. The reels are dark blue in color and is made of polystyrene plastic (anti-static coated). Other option comes in 500 units per 7" or 177cm diameter reel. This and some other options are further described in the Packaging Information table.

These full reels are individually barcode labeled and placed inside a standard intermediate box (illustrated in figure 1.0) made of recyclable corrugated brown paper. One box contains two reels maximum. And these boxes are placed inside a barcode labeled shipping box which comes in different sizes depending on the number of parts shipped.

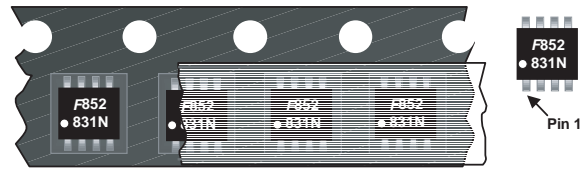

SSOT-8 Unit Orientation

SSOT-8 Packaging Information		
Packaging Option	Standard (no flow code)	D84Z
Packaging type	TNR	TNR
Qty per Reel/Tube/Bag	3,000	500
Reel Size	13" Dia	7" Dia
Box Dimension (mm)	343x64x343	184x187x47
Max qty per Box	6,000	1,000
Weight per unit (gm)	0.0416	0.0416
Weight per Reel (kg)	0.5615	0.0980
Note/Comments		

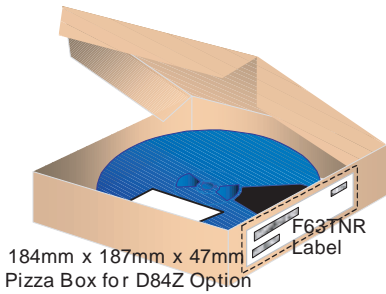
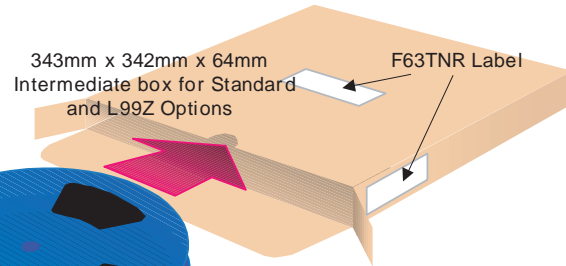

F63TNR Label sample



SSOT-8 Tape Leader and Trailer Configuration: Figure 2.0

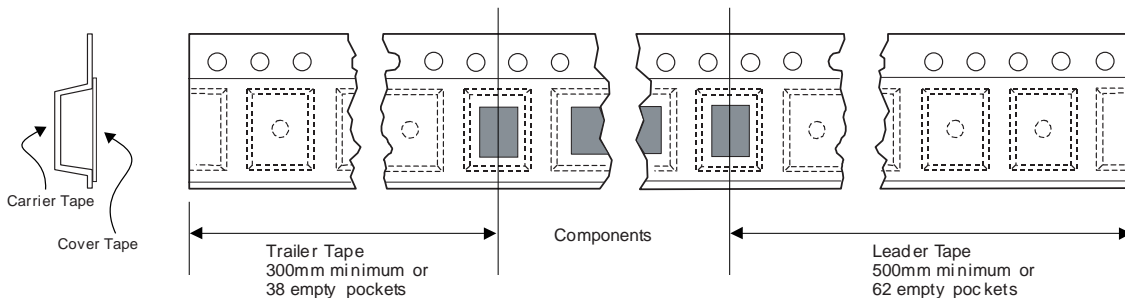

SuperSOT™-8 Tape and Reel Data and Package Dimensions, continued

SSOT-8 Embossed Carrier Tape Configuration: Figure 3.0

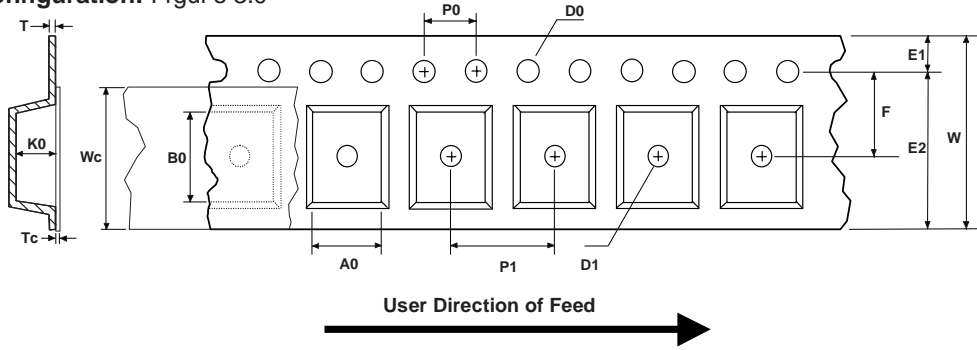

Dimensions are in millimeter

Pkg type	A0	B0	W	D0	D1	E1	E2	F	P1	P0	K0	T	Wc	Tc
SSOT-8 (12mm)	4.47 +/-0.10	5.00 +/-0.10	12.0 +/-0.3	1.55 +/-0.05	1.50 +/-0.10	1.75 +/-0.10	10.25 min	5.50 +/-0.05	8.0 +/-0.1	4.0 +/-0.1	1.37 +/-0.10	0.280 +/-0.150	9.5 +/-0.025	0.06 +/-0.02

Notes: A0, B0, and K0 dimensions are determined with respect to the EIA/Jedec RS-481 rotational and lateral movement requirements (see sketches A, B, and C).

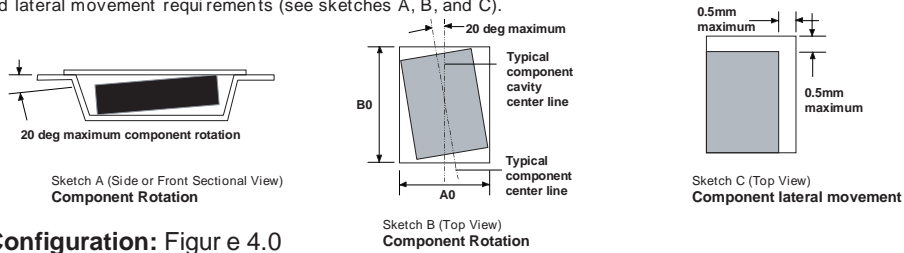

SSOT-8 Reel Configuration: Figure 4.0

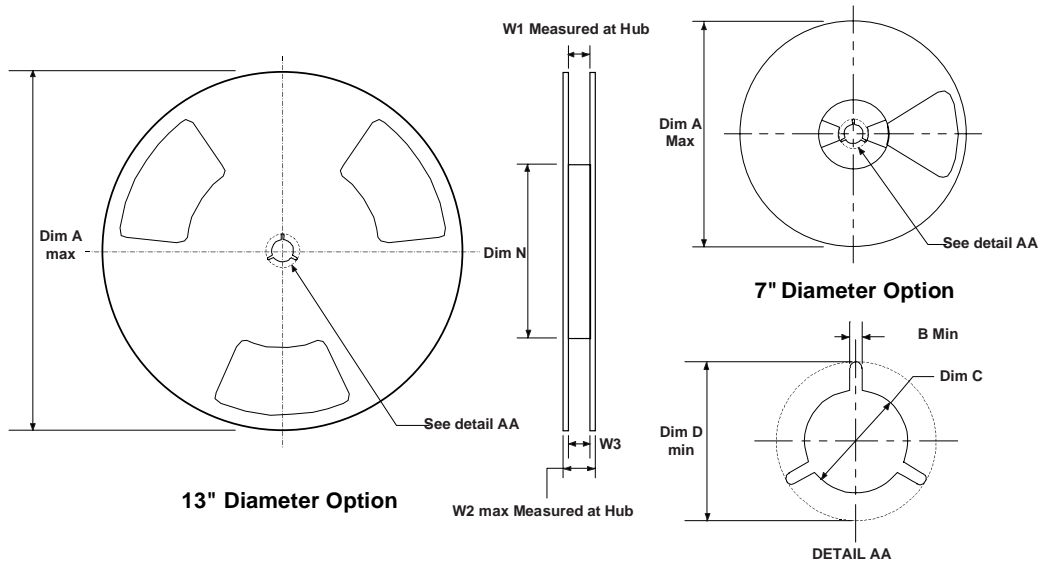

Dimensions are in inches and millimeters

Tape Size	Reel Option	Dim A	Dim B	Dim C	Dim D	Dim N	Dim W1	Dim W2	Dim W3 (LSL-USL)
12mm	7" Dia	7.00 177.8	0.059 1.5	512 +0.020/-0.008 13 +0.5/-0.2	0.795 20.2	5.906 150	0.488 +0.078/-0.000 12.4 +20	0.724 18.4	0.469 - 0.606 11.9 - 15.4
12mm	13" Dia	13.00 330	0.059 1.5	512 +0.020/-0.008 13 +0.5/-0.2	0.795 20.2	7.00 178	0.488 +0.078/-0.000 12.4 +20	0.724 18.4	0.469 - 0.606 11.9 - 15.4

SuperSOT™-8 Tape and Reel Data and Package Dimensions, continued

SuperSOT™-8 (FS PKG Code 34, 35)

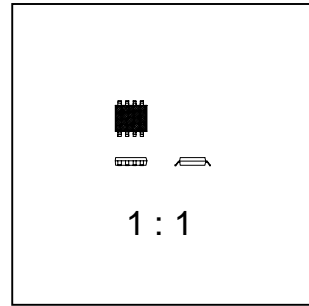
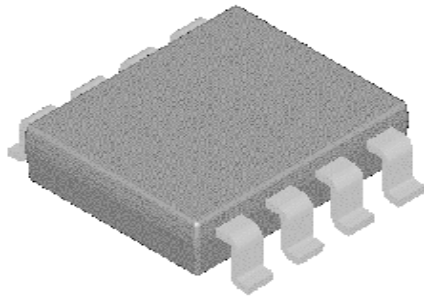

Scale 1:1 on letter size paper

Dimensions shown below are in:
inches [millimeters]

Part Weight per unit (gram): 0.0416

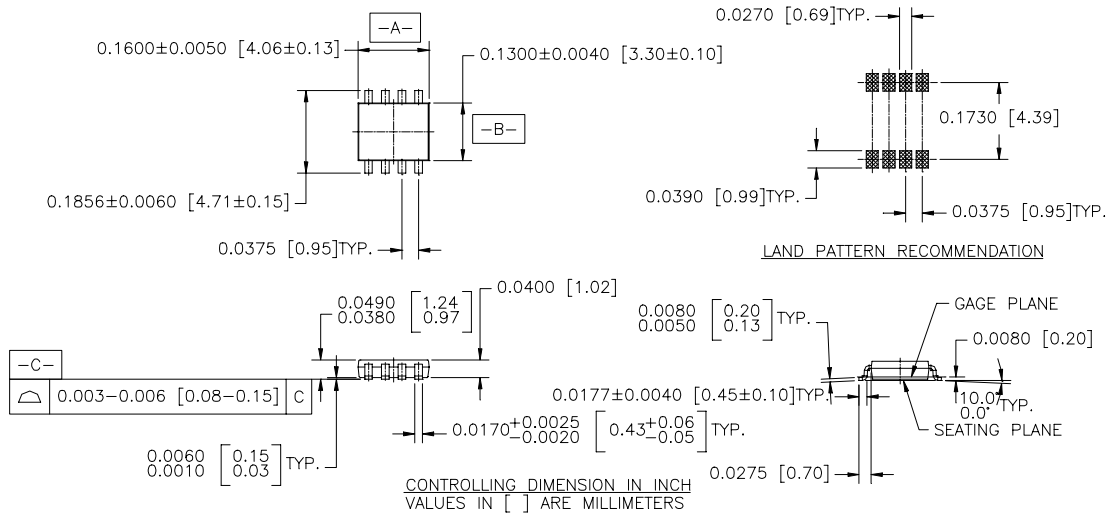

NOTES : UNLESS OTHERWISE SPECIFIED

- STANDARD LEAD FINISH TO BE 200 MICRONS / 5.08 MICROMETERS MINIMUM TIN/LEAD (SOLDER) ON COPPER.
- NO JEDEC REGISTRATION AS JAN. 1996

SUPER SOT, 8 LEADS

TRADEMARKS

The following are registered and unregistered trademarks Fairchild Semiconductor owns or is authorized to use and is not intended to be an exhaustive list of all such trademarks.

ACEx™	ISOPLANAR™	UHC™
CoolFET™	MICROWIRE™	VCX™
CROSSVOLT™	POP™	
E ² CMOS™	PowerTrench™	
FACT™	QST™	
FACT Quiet Series™	Quiet Series™	
FAST®	SuperSOT™-3	
FASTr™	SuperSOT™-6	
GTO™	SuperSOT™-8	
HiSeC™	TinyLogic™	

DISCLAIMER

FAIRCHILD SEMICONDUCTOR RESERVES THE RIGHT TO MAKE CHANGES WITHOUT FURTHER NOTICE TO ANY PRODUCTS HEREIN TO IMPROVE RELIABILITY, FUNCTION OR DESIGN. FAIRCHILD DOES NOT ASSUME ANY LIABILITY ARISING OUT OF THE APPLICATION OR USE OF ANY PRODUCT OR CIRCUIT DESCRIBED HEREIN; NEITHER DOES IT CONVEY ANY LICENSE UNDER ITS PATENT RIGHTS, NOR THE RIGHTS OF OTHERS.

LIFE SUPPORT POLICY

FAIRCHILD'S PRODUCTS ARE NOT AUTHORIZED FOR USE AS CRITICAL COMPONENTS IN LIFE SUPPORT DEVICES OR SYSTEMS WITHOUT THE EXPRESS WRITTEN APPROVAL OF FAIRCHILD SEMICONDUCTOR CORPORATION. As used herein:

1. Life support devices or systems are devices or systems which, (a) are intended for surgical implant into the body, or (b) support or sustain life, or (c) whose failure to perform when properly used in accordance with instructions for use provided in the labeling, can be reasonably expected to result in significant injury to the user.
2. A critical component is any component of a life support device or system whose failure to perform can be reasonably expected to cause the failure of the life support device or system, or to affect its safety or effectiveness.

PRODUCT STATUS DEFINITIONS

Definition of Terms

Datasheet Identification	Product Status	Definition
Advance Information	Formative or In Design	This datasheet contains the design specifications for product development. Specifications may change in any manner without notice.
Preliminary	First Production	This datasheet contains preliminary data, and supplementary data will be published at a later date. Fairchild Semiconductor reserves the right to make changes at any time without notice in order to improve design.
No Identification Needed	Full Production	This datasheet contains final specifications. Fairchild Semiconductor reserves the right to make changes at any time without notice in order to improve design.
Obsolete	Not In Production	This datasheet contains specifications on a product that has been discontinued by Fairchild semiconductor. The datasheet is printed for reference information only.